

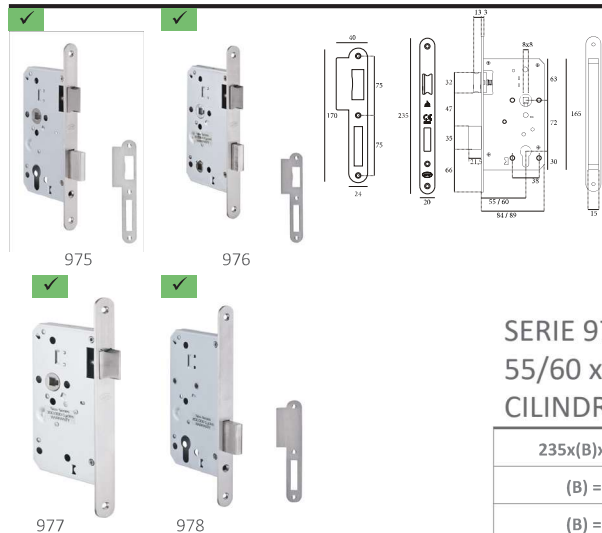

SERIE 970



Cerradura de embutir para bombillo europeo.  
Indicada para puertas con uso elevado.

SERIE 970 RED.  
55/60 x 72 mm  
CILINDRO

Ac. Inoxidable ✓



235x(B)x72x20 mm	975 Golpe y llave	976 Condena	977 Picaporte	978 Sólo llave
(B) = 55 mm	F10632097555	F10632097655	F10632097755	F10632097855
(B) = 60 mm	F10632097560	F10632097660	F10632097760	F10632097860

SERIE 130

TESA

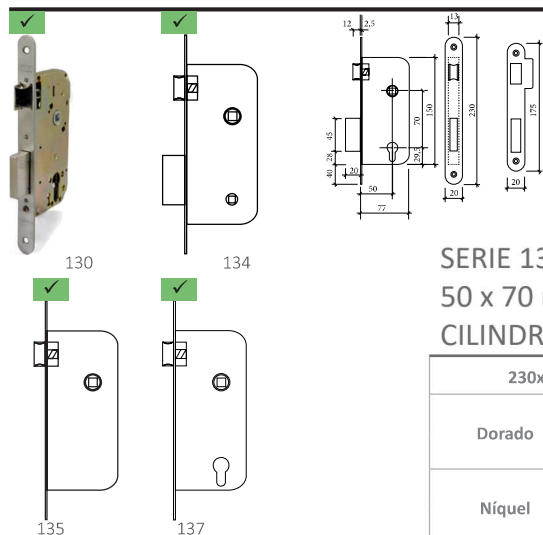

Cerradura de embutir para puertas de madera. Distancia entre ejes: 70mm. Nueca de 8mm. Nueca de condena de 6mm. Reversible. Frente estrecho adecuado para puertas con solapa. Opcional: Redondeado 1/2. Caja cerrada: impide la entrada de viruta. Cerradura/cerradero unificados para toda la gama. Cilindro europeo TE-5 con 3 llaves de acero niquelado. Acabado HL/AE: cilindro acabado latón.

Dorado ✓  
Níquel ✓

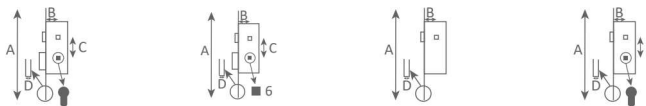

SERIE 130  
50 x 70 mm  
CILINDRO

230x50x70x20 mm		130 Golpe y llave	134 Condena	135 Picaporte	137 Golpe condena
Dorado	Redondo	F102513058RHL	F102513458RHL	F102513558RHL	
	Recto	F102513058CHL	F102513458CHL	F102513558CHL	
Níquel	Redondo	F102513058RHN		F102513558RHN	F102513758RHN
	Recto	F102513058CHN	F102513458CHN	F102513558CHN	F102513758CHN

SERIE 270

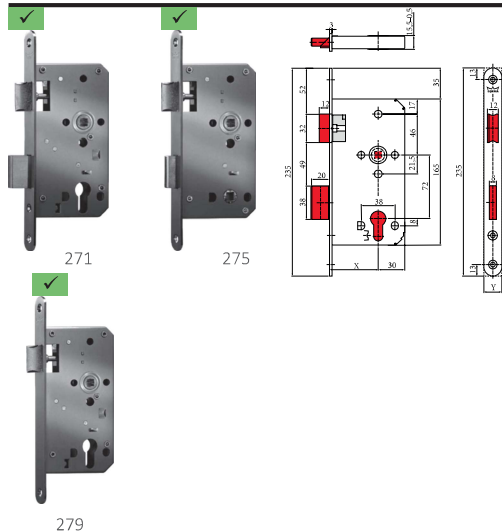

Resbalón y palanca de níquel. Palanca 20 mm, 2 vueltas. Nueca de 8 mm. Orificios pasantes para guarniciones (manillas, etc.). Caja de la cerradura cerrada, galvanizada; medidas europeas. UNE EN 12209 clase 2: Frecuencia de uso medio. No guarda mano. Resbalón reversible. Frente acero inoxidable AISI 304. Alto nivel de resistencia a la corrosión.

Ac. Inoxidable ✓

SERIE 270 RED.  
55X72 mm  
CILINDRO



235x55x72x24 mm	271 Golpe y llave	275 Condena B=78 mm	279 Picaporte
Ac. Inoxidable	F1071001	F1071002	F1071003

SERIE 2030

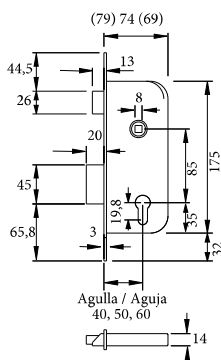
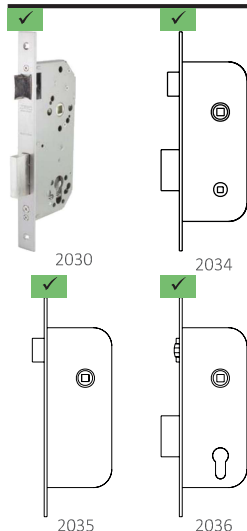

Cerradura de embutir para puertas de madera. Distancia entre ejes: 85mm. Entradas de 40/ 50/ 60/ 70mm. Nueca de 8mm. Nueca de condensa de 6mm. Reversible. Opcional: Redondeado 1/2. Cilindro europerfil TE-5 con 3 llaves de acero niquelado. Acabado HL, HE: cilindro latón. Acabado HN, Al, NE: cilindro niquel.

- Ac. Inoxidable
- Níquel
- Dorado

SERIE 2030 G./Y LLAVE  
40/50/60/70x85 mm  
CILINDRO

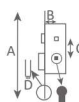

235x(B)x85x20 mm		2030 Golpe y llave con cilindro 30+30		2030 Golpe y llave sin cilindro		2030 Golpe y llave con cil. Silencioso	
		Recto	Redondo	Recto	Redondo	Recto	Redondo
(B)=40 mm	Dorado	F1025203040HL					
	Níquel	F1025203040HN		F1025403040HN			
	Inox						
(B)=50 mm	Dorado	F1025203050HL		F1025403050HL			
	Níquel	F1025203050HN	F102520305RHN	F1025403050HN	F102540305RHN		
	Inox			F1025403050AI	F102540305RAI		F1025203050IR
(B)=60 mm	Dorado	F1025203060HL					
	Níquel	F1025203060HN		F1025403060HN			
	Inox		F102520305RAI	F1025403060AI	F1025403060IR		
(B)=70 mm	Níquel			F1025403070HN			

SERIE 2030  
40/50/60x85 mm  
CILINDRO

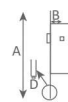
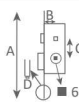
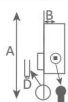

235x(B)x85x20 mm		2031 Solo llave sin cilindro		2034 Golpe y condensa		2035 Picaporte	
		Recto	Redondo	Recto	Redondo	Recto	Redondo
(B)=40 mm	Dorado						
	Níquel	F1025403140HN					
	Inox						
(B)=50 mm	Dorado				F102520345RHL	F102520355HL	
	Níquel	F1025403150HN	F1025403150RN		F102520345RHN	F102520355HN	F102520355RHN
	Inox				F102520345RAI		
(B)=60 mm	Dorado						
	Níquel	F1025403160HN	F1025403160NR				
	Inox			F1025203460AI			

SERIE 2030 VAIVEN  
50x85 mm  
CILINDRO

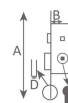

235x(B)x85x20 mm		2036 Vaivén con cilindro 30+30 mm	
		Recto	Redondo
(B)=50 mm	Dorado		
	Níquel	F102520365CHN	F102520365RHN
	Inox		



SERIE A55

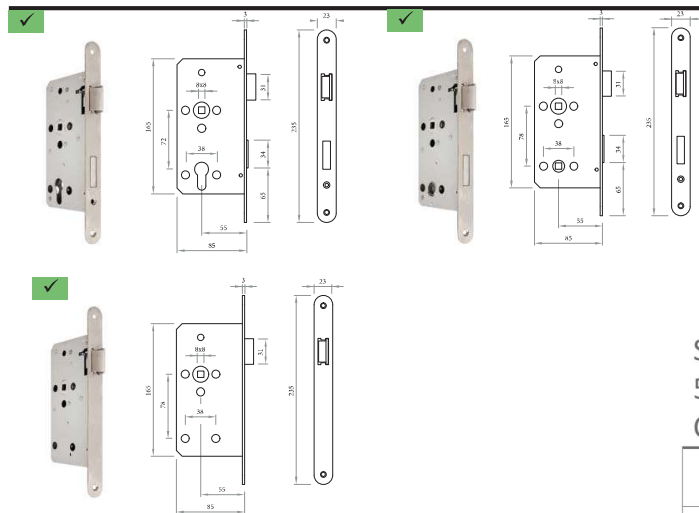

Picaporte reversible con placa intermedia en acero inoxidable, nueca en acero inoxidable con muelle interior para eliminación de holgura en cuadradillo, bulón de acero inoxidable, agujeros para tornillos pasantes. Indicadas para puertas de uso frecuente.

SERIE A55 RED.  
55x72 mm  
CILINDRO

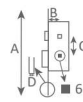
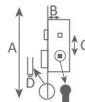

Ac. Inoxidable ✓

235x55x72x23 mm	Golpe y llave	Golpe y condena B=78 mm	Picaporte
Ac. Inoxidable	F1039A5572	F1039A5578	F1039A55

SERIE 800 MAGNÉTICA

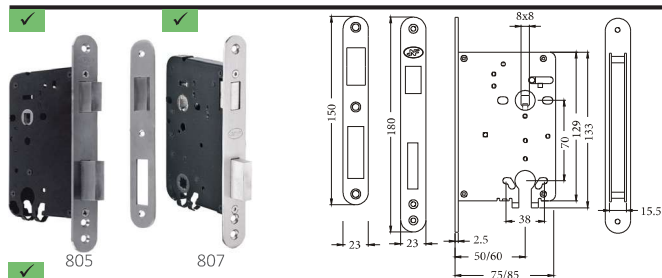

Cerradura de embutir magnetica para bombillo Europeo. Indicada para puertas con uso mediano.

SERIE 800 MAGN.RED  
50/60 x 70 mm  
CILINDRO

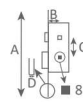
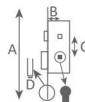

Ac. Inoxidable ✓

180x(B)x70x23 mm	805 Golpe y llave	807 Condena	808 Picaporte
(B) = 50 mm	F10632080550	F10632080750	F10632080850
(B) = 60 mm	F10632080560	F10632080760	F10632080860

SERIE POLARIS MAGNÉTICA

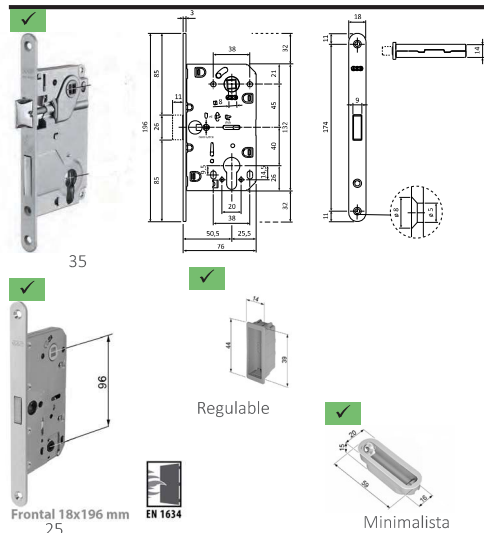

Cerradura magnética, especialmente indicada para puertas interiores de diseño moderno y líneas limpias. Incomparable versatilidad gracias al diseño innovador del cerradero que puede ser utilizado tanto para puertas lisas como solapadas, de madera o de aluminio. Polaris XT se distingue por el cierre completamente suave y silencioso, por el preciso ajuste y por la sensación de fluidez sentida tanto en la manilla como en la llave.

El cerradero regulable necesita la placa cerradero de la serie Evolution.

SER.POLARIS  
MAGN.RED.  
50 mm. CIL.

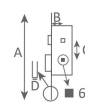
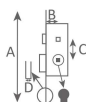

- Latonado ✓
- Níquel satinado ✓
- Cromo mate ✓
- Negro ✓

196x50x(C)x18 mm	35 Golpe y llave C=85 mm	25 Golpe y condena C=96 mm	Cerradero minimal	Cerradero Regulable
Latonado	F1067061035003	F1067061025003	F1067024020503	
Níquel satinado	F1067061035013	F1067061025013	F1067024020506	
Cromo mate	F1067061035034	F1067061025034	F1067024020534	F1067024029478
Negro	F1067061035093	F1067061025093	F1067024020593	F1067024029493



SERIE 890 SILENCIOSA

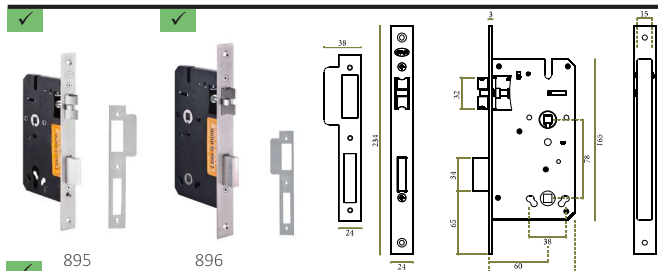

Cerradura de embutir para bombillo europeo.  
Indicada para puertas con uso elevado.



895



896

897

SERIE 890 SIL.  
60 mm  
CILINDRO

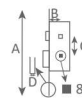
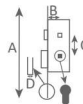

Ac. Inoxidable ✓

234x60x(C)x24 mm	895 Golpe y llave C=72 mm	896 Condensa C=78 mm	897 Picaporte
Recto	F106320895	F106320896	F106320897
Redondo	F106320895R	F106320896R	F106320897R

SERIE EVOLUTION SILENCIOSA

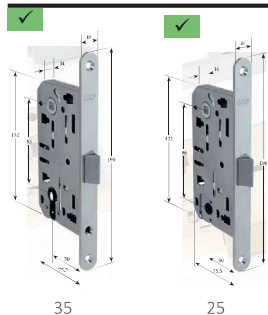

Cerraduras para puertas interiores lisas con pestillo central de poliamida, haciéndola silenciosa, fiable y robusta en el cierre. Con Quick Latch®, el nuevo cierre rápido patentado, gracias al cual, podrá orientar el pestillo y cambiar la mano de la cerradura en solo unos segundos. Las cerraduras Mediana Evolution, se caracterizan por su cierre extremadamente silencioso, por el ajuste preciso y por la sensación de fluidez en el movimiento que se siente en la manilla y en la llave.

Latonado ✓  
Níquel satinado ✓  
Cromo mate ✓  
Negro ✓

EVOLUTION SIL.RED.  
50 mm  
CILINDRO

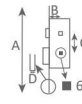
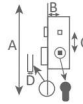

196x50x(C)x18 mm	35 Golpe y llave C=85 mm	25 Golpe y condensa C=96 mm	Placa cerradero
Latonado	F1067011035003	F1067011025003	F1067014029603
Níquel satinado	F1067011035013	F1067011025013	F1067014029606
Cromo mate	F1067011035034	F1067011025034	F1067014029634
Negro	F1067011035093	F1067011025093	F1067014029693

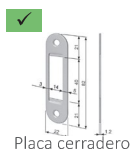

Placa cerradero

SERIE 72 SILENCIOSA



Calidad del resorte recuperador superior a: 200.000 ciclos en el deslizamiento, 50.000 ciclos en el pestillo.

Latonado ✓  
Ac. Inoxidable ✓

SERIE 720 SIL. RECTA  
50/60x72 mm  
CILINDRO

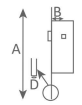
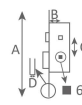
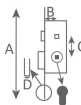

		728 Golpe y llave 194x50x72x50		724 Golpe y condensa 194x50x72x25 mm		721 Picaporte 141x(B)x25 mm
		Derecha	Izquierda	Derecha	Izquierda	
B=50	Latón	F100672850LD	F100672850LE	F100672450LMD		
	Ac.Inoxidable		F100672850IE		F100672450IME	
B=60	Latón					
	Ac.Inoxidable					F100672160IM

SERIE 900 SILENCIOSA

Caja centrada respecto al frente. Orificios pasantes para colocación de manetas de 38 mm. Herederas de las cerraduras Tecnolar.



900

883



890

SERIE 900 SIL.RECTA  
50/60x72 mm  
CILINDRO

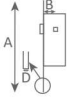
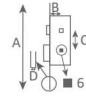
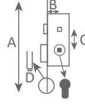

Latonado   
Ac. Inoxidable

		883 Golpe y llave 210x(B)x72x50		890 Golpe y condensa 210x(B)x70x25 mm		900 Picaporte 140x(B)x25 mm
		Derecha	Izquierda	Derecha	Izquierda	
B=50	Latón	F102988350LMD	F102988350LMI	F102989050LMD	F102989050LMI	F102990050LM
	Ac.Inoxidable	F102988350IMD	F102988350IMI	F102989050IMD	F102989050IMI	F102990050IM
B=60	Latón	F102988360LMD	F102988360LMI	F102989060LMD	F102989060LMI	F102990060LM
	Ac.Inoxidable	F102988360IMD	F102988360IMI	F102989060IMD	F102989060IMI	F102990060IM

2010



La cerradura 2010 de TESA es la cerradura ideal para la reposición en puertas de portal y entrada ya que se adapta perfectamente a los cajeados existentes en multitud de puertas del mercado.

Características principales: La cerradura puede ser combinada con un cilindro de seguridad europerfil. Cerradura de embutir para puertas de madera. 3 llaves de acero niquelado

- Dorado
- Níquel

2010  
40/50 x 47 mm  
CILINDRO

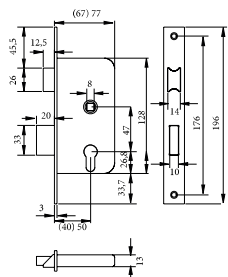
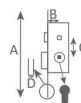

196x(B)x47x(D)		Con cilindro 30+30		Sin cilindro	
		Redondo	Recto	Redondo	Recto.
B=40	Dorado				F1025401040HL
	Níquel				F1025401040HN
B=50	Dorado			F102540105PRL	F1025401050HL
	Níquel	F1025201050PR	F1025201050PN	F102540105PRN	F1025401050HN

N10P



- Dorado
- Níquel
- Ac. Inoxidable

N10P  
50x47 mm  
CILINDRO

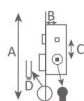

Ax50x47xD mm		Recto	Redondo
B=50	Dorado	F10992026120	F10992026123
	Níquel	F10992026121	F10992026124
	Inox	F10992026122	F10992026125

3100

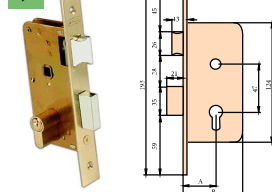

- Dorado
- Níquel

3100 RECTO  
35/40/45/50x47 mm  
CILINDRO

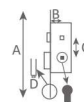

193x(B)x47xD mm	Dorado	Níquel
B=35 mm	F1028310035D	F1028310035N
B=40 mm	F1028310040D	F1028310040N
B=45 mm	F1028310045D	F1028310045N
B=50 mm	F1028310050D	F1028310050N

K30

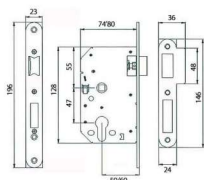

- Dorado
- Níquel

K30  
50/60x47 mm  
CILINDRO

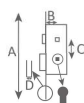

196x(B)x47x24 mm		Recto	Redondo
B=50	Dorado	F1053K3050CL	F1053K3050RL
	Níquel	F1053K3050CNS	F1053K3050RNS
B=60	Dorado		F1053K3060RL
	Níquel		F1053K3060RN

2501

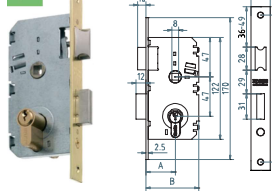

De 1 punto. Medida entre ejes 47mm. Entradas: 35, 45 y 50 mm. Picaporte y palanca niquelados. Medidas de frente: Frente N: 23 x 150mm. Frente L: 23 x 176mm. Frente y cerradero canto recto. Palanca deslizante proyectada 12mm a 1 vuelta. Caja cerrada de acero galvanizado. Picaporte reversible y accionable mediante manilla o llave. Cilindro de perfil con excéntrica de radio 15mm serie E. Acabados: latonado / niquelado.

- Dorado
- Níquel

2501 RECTO  
35/45/50x47 mm  
CILINDRO

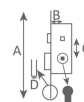

170x(B)x47x23 mm	Dorado	Níquel
B=35 mm	F10802501235	F10802501135
B=45 mm	F10802501245	F10802501145
B=50 mm	F10802501250	F10802501150

1301

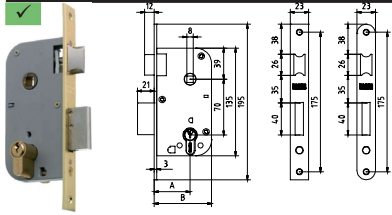

Cerradura paso de embutir para puerta de madera MCM 1301 de 1 punto con picaporte reversible, palanca de 2 vueltas y distancia entre ejes de 70mm.

Dorado ✓  
Níquel ✓

1301 RECTO  
35/40/45/50x70 mm  
CILINDRO



175x(B)x70x23 mm	Dorado	Níquel
B=35 mm	F10801301235	F10801301135
B=40 mm	F10801302140	
B=45 mm	F10801301245	F10801301145
B=50 mm	F10801301250	F10801301150

K25

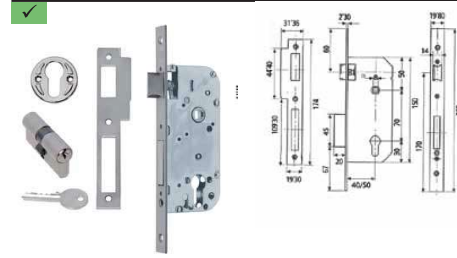

Dorado ✓  
Níquel ✓

K25  
50x70 mm  
CILINDRO

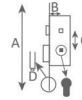

229x50x70x20	Recto	Redondo
Dorado	F1053K2550CL	F1053K2550RL
Níquel	F1053K2550CN	F1053K2550RN

N30



Dorado ✓  
Níquel ✓  
Ac. Inoxidable ✓

N30  
50x85 mm  
CILINDRO

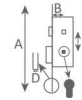

Ax85xC	B=50 mm		B=60 mm	
	Recto	Redondo	Recto	Redondo
Dorado	F10992026138	F10992026141	F10992026144	F10992026147
Níquel	F10992026139	F10992026142	F10992026145	F10992026148
Ac. Inoxidable	F10992026140	F10992026143	F10992026146	F10992026149

IN.20.275

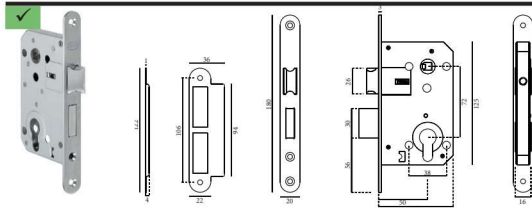

Ac. Inoxidable ✓

IN.20.275 RED.  
50x72 mm  
CILINDRO

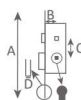

180x50x72x20 mm	
Ac. Inoxidable	F10632027550

1024



Ac. Inoxidable ✓

1024 REDONDO  
50x85 mm  
CILINDRO

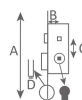

Ax50x85xD mm	
Ac. Inoxidable	F106710245006

K35

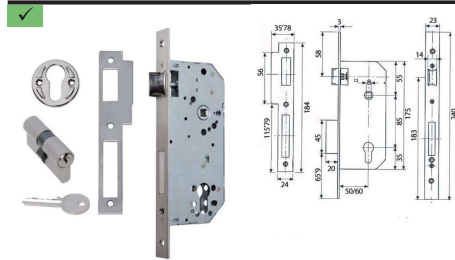

Dorado   
Níquel

K35  
50x85 mm  
CILINDRO

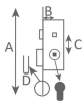

240x50x85x23	Recto	Redondo
Dorado	F1053K3550CL	F1053K3550RL
Níquel	F1053K3550CNS	F1053K3550RNS

4000

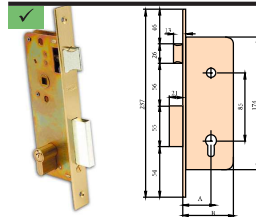

Dorado   
Níquel

3100  
50x85 mm  
CILINDRO

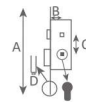

193x50x85xD mm	Dorado	Níquel
Recto	F1028400050D	F1028400050N
Redondo	F1028400050RD	F1028400050RN

825-C MAGNÉTICO



Cerradura unificada para puerta de paso con sistema magnético. Simplicidad en el montaje, no necesita cambio de mano. Resbalón y cerraderos sin salientes, con mecanizados más sencillos. Funcionamiento suave y silencioso debido a la ausencia de rozamientos. Posible utilización como dispositivo de condena o con llave gorja. El cerradero es regulable una vez colocado

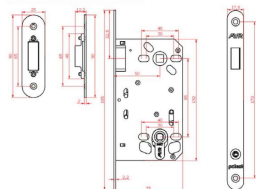

Níquel

825-C RED.  
50x85 mm  
CILINDRO



195x50x85x17.8 mm	
Níquel	F1420852385NS

340

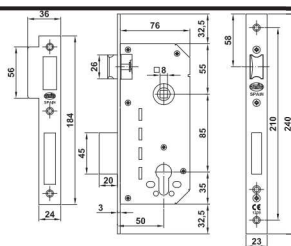

Negro

340 RECTO  
50x85 mm  
CILINDRO



240x50x85x23 mm	
Negro	F1021340NE

1508

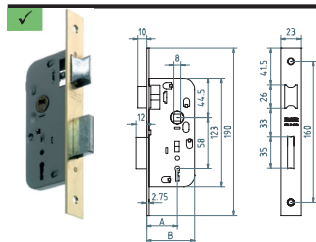

Cerradura de embutir para madera MCM 1508 de picaporte reversible, accionable mediante manilla o llave, y palanca a 1 vuelta con llave de borja. Medida entre ejes 58mm.

Dorado   
Níquel

2501 RECTO  
35/45x58 mm  
BORJAS

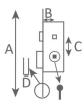

190x(B)x58x23 mm	Dorado	Níquel
B=35 mm	F10801508235	F10801508135
B=45 mm	F10801508245	F10801508145

1300-PORTERIA



Cerradura para embutir, adecuada para entrada a escaleras y parking. Solo resbalón, accionado a llave por una cara o manilla por ambas caras. Mano derecha o izquierda según encargo. Tres llaves de latón, tipo embra, una de las cuales retiene el resbalón. Seis gorjas.

Dorado

1300 RECTO  
50 x 38 mm  
BORJAS

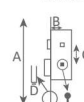

135x50x38x25 mm	Dorado
Derecha	F1065130050D
Izquierda	F1065130050E