

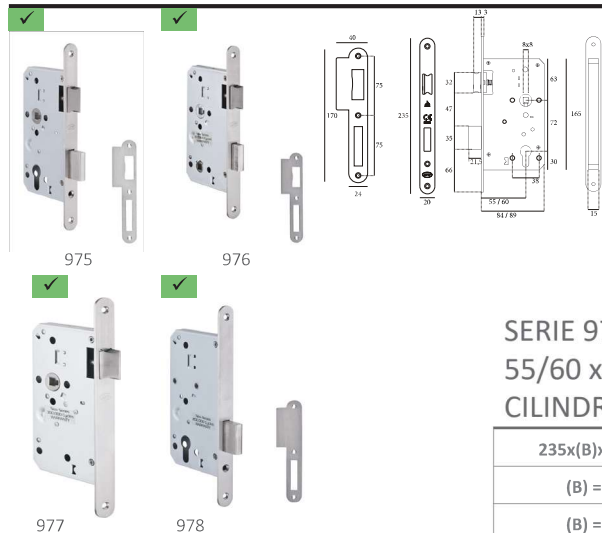

SERIE 970



Cerradura de embutir para bombillo europeo.
Indicada para puertas con uso elevado.

SERIE 970 RED.
55/60 x 72 mm
CILINDRO

Ac. Inoxidable ✓



235x(B)x72x20 mm	975 Golpe y llave	976 Condena	977 Picaporte	978 Sólo llave
(B) = 55 mm	F10632097555	F10632097655	F10632097755	F10632097855
(B) = 60 mm	F10632097560	F10632097660	F10632097760	F10632097860

SERIE 130

TESA

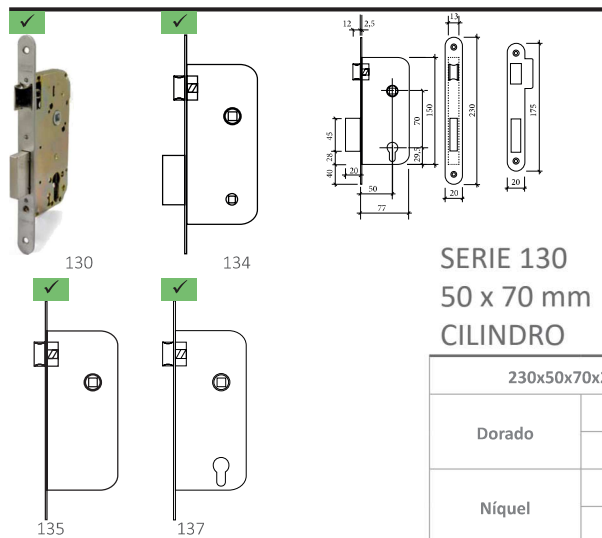

Cerradura de embutir para puertas de madera. Distancia entre ejes: 70mm. Nueca de 8mm. Nueca de condena de 6mm. Reversible. Frente estrecho adecuado para puertas con solapa. Opcional: Redondeado 1/2. Caja cerrada: impide la entrada de viruta. Cerradura/cerradero unificados para toda la gama. Cilindro europeo TE-5 con 3 llaves de acero níquelado. Acabado HL/AE: cilindro acabado latón.

Dorado ✓
Níquel ✓

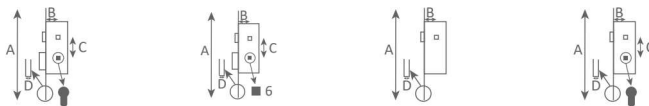

SERIE 130
50 x 70 mm
CILINDRO

230x50x70x20 mm		130 Golpe y llave	134 Condena	135 Picaporte	137 Golpe condena
Dorado	Redondo	F102513058RHL	F102513458RHL	F102513558RHL	
	Recto	F102513058CHL	F102513458CHL	F102513558CHL	
Níquel	Redondo	F102513058RHN		F102513558RHN	F102513758RHN
	Recto	F102513058CHN	F102513458CHN	F102513558CHN	F102513758CHN

SERIE 270

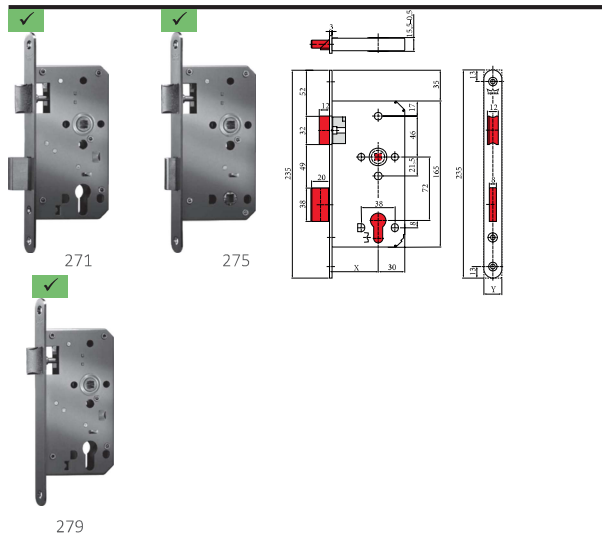

Resbalón y palanca de níquel. Palanca 20 mm, 2 vueltas. Nueca de 8 mm. Orificios pasantes para guarniciones (manillas, etc.). Caja de la cerradura cerrada, galvanizada; medidas europeas. UNE EN 12209 clase 2: Frecuencia de uso medio. No guarda mano. Resbalón reversible. Frente acero inoxidable AISI 304. Alto nivel de resistencia a la corrosión.

Ac. Inoxidable ✓

SERIE 270 RED.
55X72 mm
CILINDRO



235x55x72x24 mm	271 Golpe y llave	275 Condena B=78 mm	279 Picaporte
Ac. Inoxidable	F1071001	F1071002	F1071003

SERIE 2030

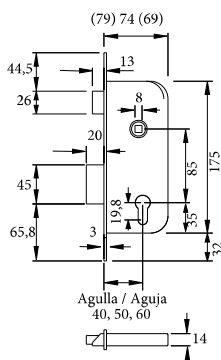
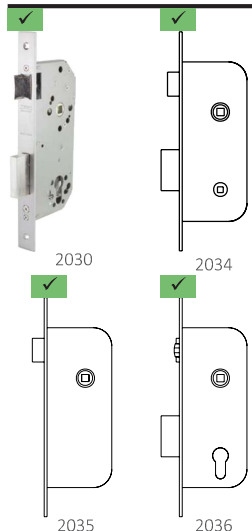

Cerradura de embutir para puertas de madera. Distancia entre ejes: 85mm. Entradas de 40/ 50/ 60/ 70mm. Nueca de 8mm. Nueca de condensa de 6mm. Reversible. Opcional: Redondeado 1/2. Cilindro europerfil TE-5 con 3 llaves de acero niquelado. Acabado HL, HE: cilindro latón. Acabado HN, Al, NE: cilindro niquel.

- Ac. Inoxidable
- Níquel
- Dorado

SERIE 2030 G/.Y LLAVE
40/50/60/70x85 mm
CILINDRO

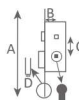

235x(B)x85x20 mm		2030 Golpe y llave con cilindro 30+30		2030 Golpe y llave sin cilindro		2030 Golpe y llave con cil. Silencioso	
		Recto	Redondo	Recto	Redondo	Recto	Redondo
(B)=40 mm	Dorado	F1025203040HL					
	Níquel	F1025203040HN		F1025403040HN			
	Inox						
(B)=50 mm	Dorado	F1025203050HL		F1025403050HL			
	Níquel	F1025203050HN	F102520305RHN	F1025403050HN	F102540305RHN		
	Inox			F1025403050AI	F102540305RAI		F1025203050IR
(B)=60 mm	Dorado	F1025203060HL					
	Níquel	F1025203060HN		F1025403060HN			
	Inox		F102520305RAI	F1025403060AI	F1025403060IR		
(B)=70 mm	Níquel			F1025403070HN			

SERIE 2030
40/50/60x85 mm
CILINDRO

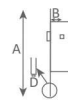
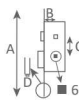
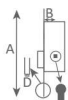

235x(B)x85x20 mm		2031 Solo llave sin cilindro		2034 Golpe y condensa		2035 Picaporte	
		Recto	Redondo	Recto	Redondo	Recto	Redondo
(B)=40 mm	Dorado						
	Níquel	F1025403140HN					
	Inox						
(B)=50 mm	Dorado				F102520345RHL	F102520355HL	
	Níquel	F1025403150HN	F1025403150RN		F102520345RHN	F102520355HN	F102520355RHN
	Inox				F102520345RAI		
(B)=60 mm	Dorado						
	Níquel	F1025403160HN	F1025403160NR				
	Inox			F1025203460AI			

SERIE 2030 VAIVEN
50x85 mm
CILINDRO

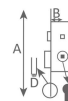

235x(B)x85x20 mm		2036 Vaivén con cilindro 30+30 mm	
		Recto	Redondo
(B)=50 mm	Dorado		
	Níquel	F102520365CHN	F102520365RHN
	Inox		



SERIE A55

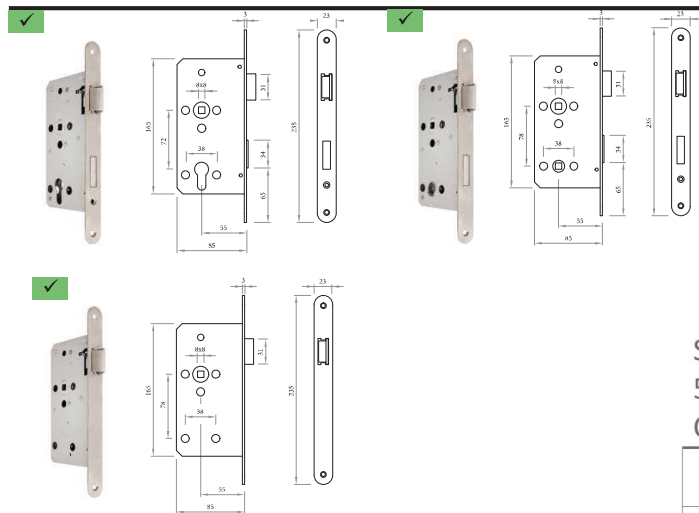

Picaporte reversible con placa intermedia en acero inoxidable, nueca en acero inoxidable con muelle interior para eliminación de holgura en cuadradillo, bulón de acero inoxidable, agujeros para tornillos pasantes. Indicadas para puertas de uso frecuente.

SERIE A55 RED.
55x72 mm
CILINDRO

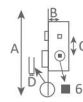
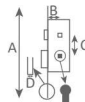

Ac. Inoxidable ✓

235x55x72x23 mm	Golpe y llave	Golpe y condensa B=78 mm	Picaporte
Ac. Inoxidable	F1039A5572	F1039A5578	F1039A55

SERIE 800 MAGNÉTICA

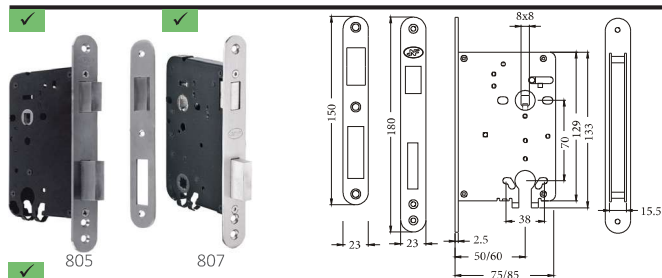

Cerradura de embutir magnetica para bombillo Europeo. Indicada para puertas con uso mediano.

SERIE 800 MAGN.RED
50/60 x 70 mm
CILINDRO

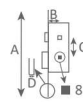
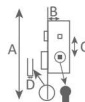

Ac. Inoxidable ✓

180x(B)x70x23 mm	805 Golpe y llave	807 Condensa	808 Picaporte
(B) = 50 mm	F10632080550	F10632080750	F10632080850
(B) = 60 mm	F10632080560	F10632080760	F10632080860

SERIE POLARIS MAGNÉTICA

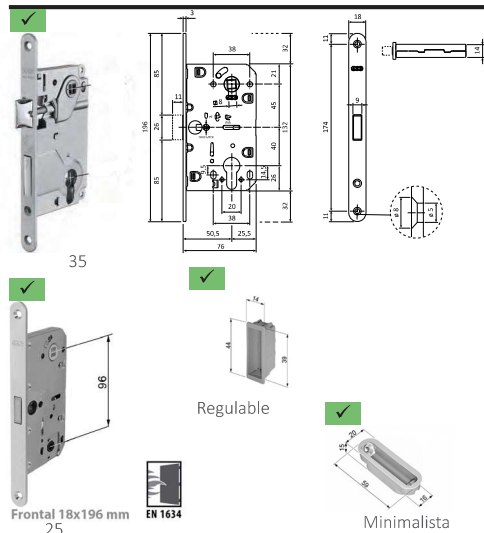

Cerradura magnética, especialmente indicada para puertas interiores de diseño moderno y líneas limpias. Incomparable versatilidad gracias al diseño innovador del cerradero que puede ser utilizado tanto para puertas lisas como solapadas, de madera o de aluminio. Polaris XT se distingue por el cierre completamente suave y silencioso, por el preciso ajuste y por la sensación de fluidez sentida tanto en la manilla como en la llave.

El cerradero regulable necesita la placa cerradero de la serie Evolution.

SER.POLARIS
MAGN.RED.
50 mm. CIL.

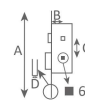
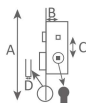

- Latonado ✓
- Níquel satinado ✓
- Cromo mate ✓
- Negro ✓

196x50x(C)x18 mm	35 Golpe y llave C=85 mm	25 Golpe y condensa C=96 mm	Cerradero minimal	Cerradero Regulable
Latonado	F1067061035003	F1067061025003	F1067024020503	
Níquel satinado	F1067061035013	F1067061025013	F1067024020506	
Cromo mate	F1067061035034	F1067061025034	F1067024020534	F1067024029478
Negro	F1067061035093	F1067061025093	F1067024020593	F1067024029493



SERIE 890 SILENCIOSA

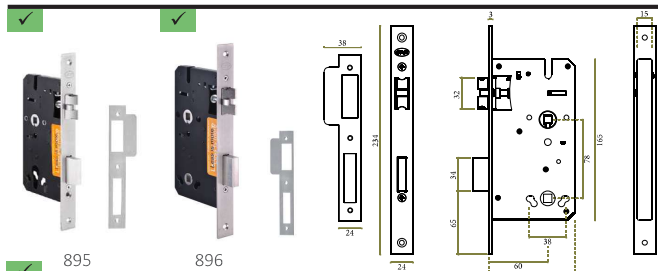

Cerradura de embutir para bombillo europeo.
Indicada para puertas con uso elevado.

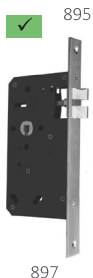

896

SERIE 890 SIL.
60 mm
CILINDRO

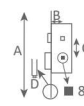
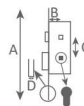

Ac. Inoxidable ✓

234x60x(C)x24 mm	895 Golpe y llave C=72 mm	896 Condensa C=78 mm	897 Picaporte
Recto	F106320895	F106320896	F106320897
Redondo	F106320895R	F106320896R	F106320897R

SERIE EVOLUTION SILENCIOSA

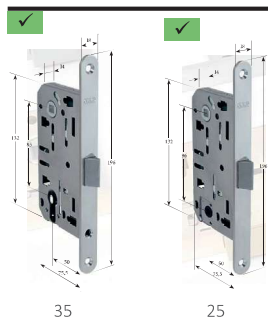

Cerraduras para puertas interiores lisas con pestillo central de poliamida, haciéndola silenciosa, fiable y robusta en el cierre. Con Quick Latch®, el nuevo cierre rápido patentado, gracias al cual, podrá orientar el pestillo y cambiar la mano de la cerradura en solo unos segundos. Las cerraduras Mediana Evolution, se caracterizan por su cierre extremadamente silencioso, por el ajuste preciso y por la sensación de fluidez en el movimiento que se siente en la manilla y en la llave.

Latonado ✓
Níquel satinado ✓
Cromo mate ✓
Negro ✓

EVOLUTION SIL.RED.
50 mm
CILINDRO

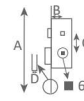
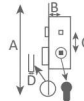

196x50x(C)x18 mm	35 Golpe y llave C=85 mm	25 Golpe y condensa C=96 mm	Placa cerradero
Latonado	F1067011035003	F1067011025003	F1067014029603
Níquel satinado	F1067011035013	F1067011025013	F1067014029606
Cromo mate	F1067011035034	F1067011025034	F1067014029634
Negro	F1067011035093	F1067011025093	F1067014029693

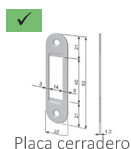

SERIE 72 SILENCIOSA



Calidad del resorte recuperador superior a: 200.000 ciclos en el deslizamiento, 50.000 ciclos en el pestillo.

SERIE 720 SIL. RECTA
50/60x72 mm
CILINDRO

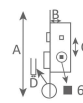
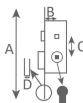

Latonado ✓
Ac. Inoxidable ✓

		728 Golpe y llave 194x50x72x50		724 Golpe y condensa 194x50x72x25 mm		721 Picaporte 141x(B)x25 mm
		Derecha	Izquierda	Derecha	Izquierda	
B=50	Latón	F100672850LD	F100672850LE	F100672450LMD		
	Ac.Inoxidable		F100672850IE		F100672450IME	
B=60	Latón					
	Ac.Inoxidable					F100672160IM

SERIE 900 SILENCIOSA

Caja centrada respecto al frente. Orificios pasantes para colocación de manetas de 38 mm. Herederas de las cerraduras Tecnolar.



900

883



890

SERIE 900 SIL.RECTA
50/60x72 mm
CILINDRO

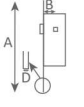
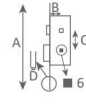
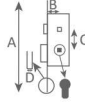

Latonado
Ac. Inoxidable

		883 Golpe y llave 210x(B)x72x50		890 Golpe y condensa 210x(B)x70x25 mm		900 Picaporte 140x(B)x25 mm
		Derecha	Izquierda	Derecha	Izquierda	
B=50	Latón	F102988350LMD	F102988350LMI	F102989050LMD	F102989050LMI	F102990050LM
	Ac.Inoxidable	F102988350IMD	F102988350IMI	F102989050IMD	F102989050IMI	F102990050IM
B=60	Latón	F102988360LMD	F102988360LMI	F102989060LMD	F102989060LMI	F102990060LM
	Ac.Inoxidable	F102988360IMD	F102988360IMI	F102989060IMD	F102989060IMI	F102990060IM

PICAPORTE UNIFICADO 70 mm GOLPE DESCENTRADO

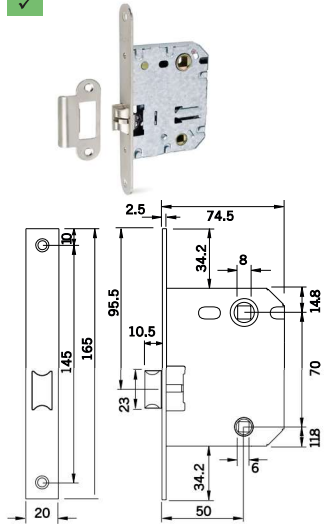

- Níquel ✓
- Dorado ✓
- Ac. Inoxidable ✓
- Bronce ✓
- Negro ✓
- Blanco ✓
- Antracita ✓

50x70 mm
DESCENTRADO



		Recto	Redondo	Redondo	Redondo
Níquel	Normal			F1053710HPR	F10990123715
	Silencioso		F1025134US5RN		
Dorado	Normal	F1025134U50HL	F1025134U5RHL	F1053700HPR	F10990123714
	Silencioso	F1025134US5QL	F1025134US5RL		F10990023705
Ac. Inoxidable	Normal	F1025134U50AI	F1025134U5RAI	F1053740HPR	F10990123713
	Silencioso		F1025134US5RI		F10990023707
Bronce	Normal			F1053720HPR	F10990124003
Negro	Normal			F1053730HPR	F10990124006
Blanco	Normal				F10990126727
Antracita	Normal				F10990127014

PICAPORTE UNIFICADO 70 mm GOLPE CENTRADO

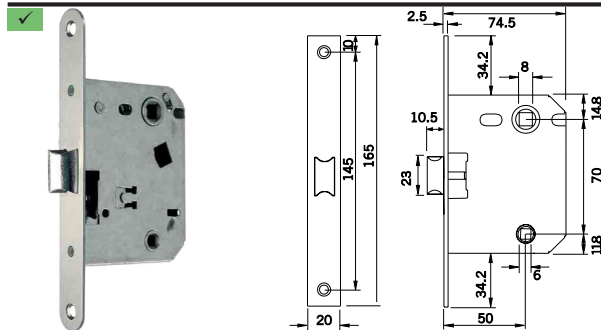

- Níquel ✓

50x70 mm
CENTRADO

		Recto	Redondo
Níquel	Normal	F10176137CN	F10176137RN

PICAPORTE UNIFICADO 47 mm

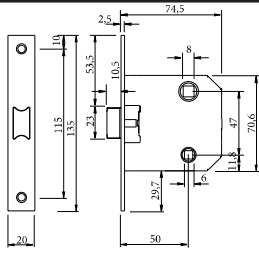

Níquel ✓
Dorado ✓

Ac. Inoxidable ✓
Bronce ✓

TESA

hpro



50x47 mm

		Recto	Redondo	Recto	Redondo	Recto	Redondo	Redondo
Níquel	Normal	F10252004U50N		F1053510HP	F1053510HPR	F10176134CN	F10176134RN	F10990223712
	Silencioso	F10252004SU5N						
Dorado	Normal	F10252004U50L	F10252004U5RL	F1053500HP	F1053500HPR			F10990223711
	Silencioso		F10252004SU5L					
Ac. Inoxi- dable	Normal	F10252004U50I	F10252004U5RA					F10990223710
	Silencioso	F10252004SU5I	F10252004SR5I					
Negro	Normal							F10990223968
	Silencioso							

2000/2001/2100

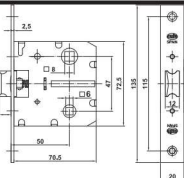

Dorado ✓
Níquel ✓
Cuero ✓
Ac.Inoxidable ✓
Negro ✓



47 mm

	Recto	Redondo	Red. Ag.Pasantes
Dorado	F10212100LL		
Níquel	F10212100NI		
Cuero	F10212100C		
Ac.Inox.	F10212100IN	F10212000I	F1021200150I
Negro	F10212100N		

1.02 Cerr madera

4000/4001

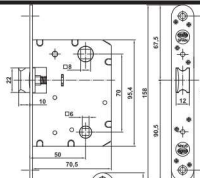

Cuero ✓
Ac.Inoxidable ✓
Negro ✓



47 mm

	Recto	Red. Ag.Pasantes
Cuero	F10214000C	
Ac.Inox.		F10214001IN
Negro		F102140001NE

12 / 2021

CERRADERO PICAP.UNIF.

TESA

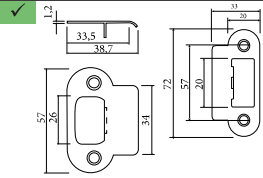

Níquel ✓
Dorado ✓

CERRADERO

	Dorado	Níquel
Recto	F1025C2004UHL	F1025C2004UHN
Redondo	F1025CR2004HL	F1025CR2004HN

819

AYR
OPENING DOORS

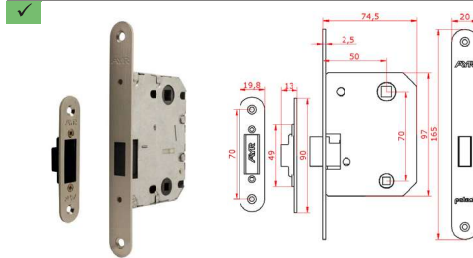

Níquel ✓
Dorado ✓

50x70 mm
MAGNÉTICO
REDONDO



	Dorado	Níquel
Redondo	F142081970LL	F142081970NS

1064-R

HERRAJES
OCARIZ

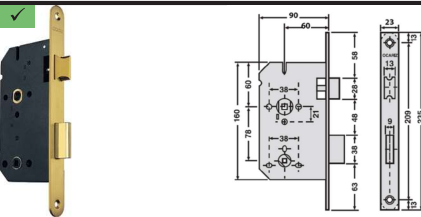

Ac. Inoxidable ✓

1064-R
60x78 mm



235x60x78x23	Recto
Ac. Inoxidable	F10491064R60CI

134U-PLUS

TESA

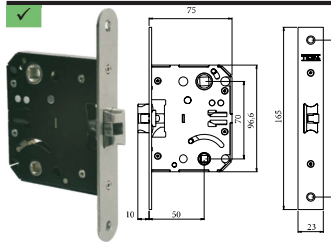

Distancia entre ejes, 70mm. Entrada 50/60. Valido indistintamente para puertas de paso o de condensa. Desbloqueo automático de condensa: si se acciona la condensa, con la puerta abierta, ésta salta al cerrarse. Picaporte reversible, de acero sinterizado y silencioso.

Ac. Inoxidable ✓
Dorado ✓

134U-PLUS
50/60x70 mm
SILENCIOSO



165x50x70x23 mm		Ac. Inoxidable	Dorado
B=50 mm	Recto		F1025134UP5HL
	Redondo	F1025134UP5IR	
B=60 mm	Recto	F1025134UP6AI	

1709X

mcm

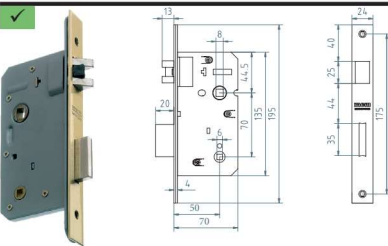

Ac. Inoxidable ✓
Dorado ✓

1709X
50x70 mm
SILENCIOSO



195x50x70x24 mm	Ac. Inoxidable	Dorado
Recto	F10801709X4	F10801709X3

2015

TESA

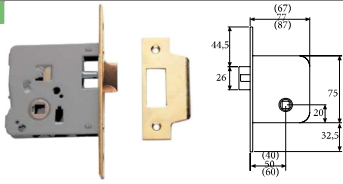

Dorado
Níquel

SOLO GOLPE RECTO



	Dorado	Níquel
B=40 mm		F1025201540HN
B=50 mm	F1025201550HL	F1025201550HN
B=60 mm		F1025201560HN

2005

TESA

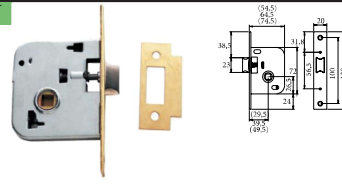

Dorado
Níquel

SOLO GOLPE RECTO



	Dorado	Níquel
B=30 mm	F1025200530HL	F1025200530HN
B=40 mm	F1025200540HL	F1025200540HN
B=60 mm	F1025200550HL	F1025200550HN

1510

mem

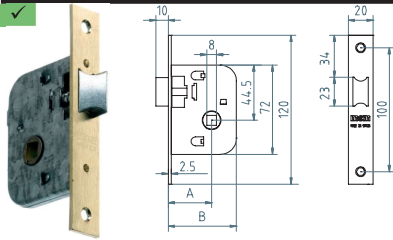

Dorado
Níquel

SOLO GOLPE RECTO



120x(B)xCx20 mm	Dorado	Níquel
B=35 mm	F10801510235L	F10801510135N
B=45 mm		F10801510145N

196R306

CVL

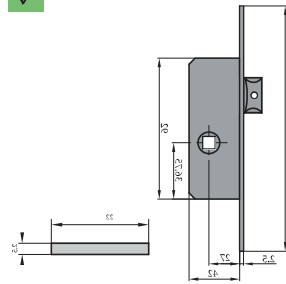

Níquel

SOLO GOLPE RECTO



160x30xCxD mm	
Níquel	F1077196R306

1710X

mem

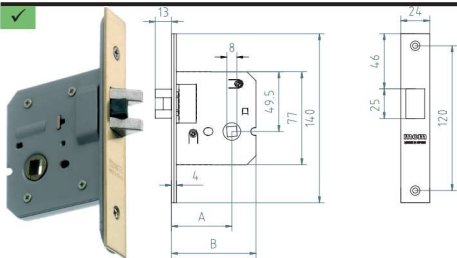

Dorado
Ac. Inoxidable

SOLO GOLPE RECTO SILENCIOSO



140x50xCx24 mm	Dorado	Ac. Inoxidable
Recto	F10801710X3	F10801710X4

16

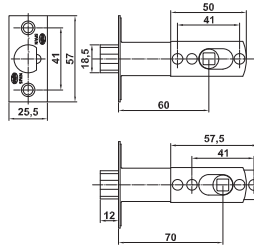

Níquel ✓
Dorado ✓



RECTO

57x60/70xCx25,5 mm	Níquel	Dorado
Recto	F102116CM	F102116LM

12

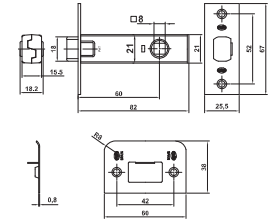

Negro ✓

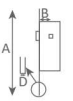

RECTO

67x(B)xCx25,5 mm	Negro
B=45 mm	F10210012045N
B=60 mm	F10210012060N

CATFER



Ac. Inoxidable ✓
Dorado ✓

Ax(B)xCxD mm	Latón	Ac. Inoxidable			Negro
		Recto	Redondo	Mixto	
B=35 mm	F14952035LQ	F14952035IQ			
B= 45 mm	F14952045LQ	F14952045IQ	F14952245IR	F14952245IM	F14952045NQ
B=60 mm	F14952160LQ	F14952160IM			
B=70 mm		F14952170IQ			
Placa cerradero	F1495PLAQL	F1495PLAQI			

PARA SISTEMA POMO



Níquel ✓
Dorado ✓



PARA POMO
TESA

	Níquel	Dorado
Picaporte canto recto	F1425P6070CC	F1425P6070CLL
Placa recta	F1425C2500HN	F1425C2500HL