

GUIA OCULTA TANDEM BLUMOTION

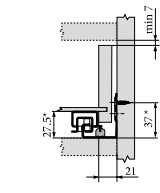

\* +3 mm amb estabilizadors laterals

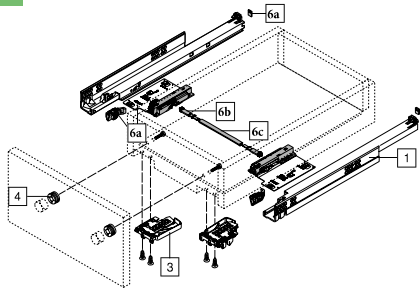
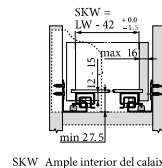

SKW Ample interior del calaix.  
LW Ample interior cos del moble

\* +3 mm con estabilizadores laterales

SKW Ancho interior del cajón  
LW Ancho interior cuerpo de mueble

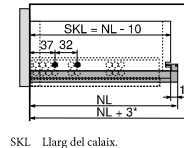

SKL Llarg del calaix.  
NL Llarg nominal.  
\* Adicionalment +12 mm amb estabilizadors laterals.

SKL Largo de cajón  
NL Largo nominal  
\* Adicionalmente +12 mm con estabilizadores laterales

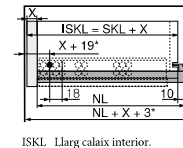

ISKL Llarg calaix interior.  
SKL Llarg del calaix.  
NL Llarg nominal.  
\* Adicionalment +2 mm amb POSISTOP

ISKL Largo del cajón interior  
SKL Largo de cajón  
NL Largo nominal  
\* Adicionalmente +2 mm con POSISTOP

Zincado

GUIA TANDEM BLUMOTION FRENO PROGRESIVO 30 Kgs.

ACCES.TANDEM BLUMOTION FRENO PROGRESIVO 30 Kgs.

Jgo fijaciones (3)	F2984T511700
--------------------	--------------

25 cms	F2984560H250
27 cms	F2984560H270
30 cms	F2984560H300
35 cms	F2984560H350
40 cms	F2984560H400
45 cms	F2984560H450
50 cms	F2984560H500
55 cms	F2984560H550

GUIA OCULTA MOVENTO BLUMOTION / BLUMOTION + TIP-ON

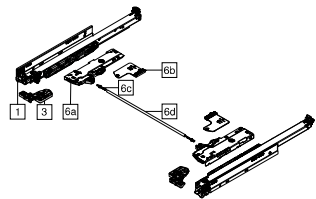

Espai ocupat en el cos  
Espacio ocupado en el cuerpo

Caixa | calaix interior  
Cajón | cajón interior

Caixa  
Cajón

Caixa interior  
Cajón interior

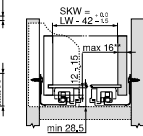
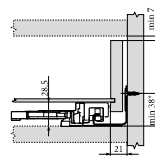

SKW Ancho interior del cajón.  
LW Ancho interior del cuerpo del mueble.

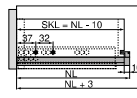

SKL Largo de cajón.  
NL Largo nominal.

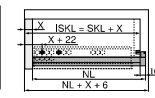

ISKL Largo calaix int.  
SKL Largo de cajón interior.  
NL Largo nominal.  
X Espesor del frontal. Espesor del frente.

Zincado

Guía Blumotion: Guía + jgo de fijaciones.  
Guía Blumotion + Tip-On: Guía + jgo. de fijaciones + Tip-on + varilla.

Amplés de moble per calaix. Anchos de mueble para cajón.

LN	300	350	400	450	500	600	700	800	900	1000	1100	1200
270	S0	S0	S0	S0	S0	S1	S1	S1	S1	S1	S1	S1
300	S0	S0	S0	S0	S1	S1	S1	S1	S1	S1	S1	S1
350	L1	L1	L1	L1	L1	L1	L1	L1	L1	L1	L3	L3
400	L1	L1	L1	L1	L1	L1	L1	L1	L1	L3	L3	L3
450	L1	L1	L1	L1	L1	L1	L1	L3	L3	L3	L3	L3
500	L1	L1	L1	L1	L1	L1	L3	L3	L3	L3	L3	L3
600	L5	L5	L5	L5	L5	L5	L5	L5	L5	L5	L5	L5

Amplés de moble per caceroler. Anchos de muebles para cacerolero.

LN	300	350	400	450	500	600	700	800	900	1000	1100	1200
270	S0	S0	S0	S0	S1	S1	S1	S1	S1	S1	S1	S1
300	S0	S0	S0	S1	S1	S1	S1	S1	S1	S1	S1	S1
350	L1	L1	L1	L1	L1	L1	L1	L1	L1	L3	L3	L3
400	L1	L1	L1	L1	L1	L1	L1	L3	L3	L3	L3	L3
450	L1	L1	L1	L1	L1	L1	L3	L3	L3	L3	L3	L3
500	L1	L1	L1	L1	L1	L3	L3	L3	L3	L5	L5	L5
600	L5	L5	L5	L5	L5	L5	L5	L5	L5	L5	L5	L5

ACCES.MOVENTO

Jgo fijaciones (3)	F2984T511760	40 Kgs	F2984760S250	60 Kgs	
Tip-on S0 (6a+6b+6c)	P	45 cms	F2984760S450	25 cms	F2984760S250
Tip-on S1 (6a+6b+6c)	F2984TIPON5	50 cms	F2984760S500	27 cms	F2984760S270
Tip-on L1 (6a+6b+6c)	F2984TIPON1	55 cms	F2984760S550	30 cms	F2984760S300
Tip-on L3 (6a+6b+6c)	F2984TIPON3	60 cms	F2984760S600	35 cms	F2984760S350
Tip-on L5 (6a+6b+6c)	F2984TIPON4	65 cms	F2984766S650	40 cms	F2984760S400
Varilla (6d)	F308439313	70 cms	F2984766S700	45 cms	F2984760S450
		75 cms	F2984766S750		

GUIA OCULTA TANDEM TIP-ON

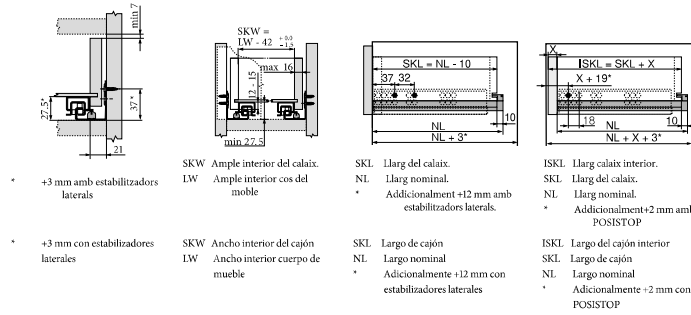
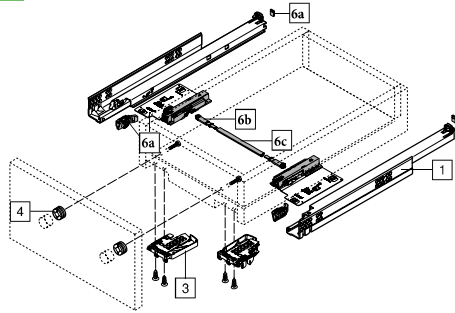

Zincado

GUIA TANDEM BLUMOTION  
TOCA - TOCA  
30 / 50 Kgs.

ACCES.TANDEM TIP-ON  
TOCA - TOCA  
30 Kgs.

Jgo fijaciones (3)	F2984T511700	25 cms	F2984562H250C
Jgo. piñones Tip-on (6b)	F2984T55000R	27 cms	F2984562H270C
Varilla Tip-on (6c)	F2984T55889W	30 cms	F2984562H300C
Toca-toca 30 kgs (6a)	F2984TIPON	35 cms	F2984562H350C
		40 cms	F2984562H400C
		45 cms	F2984562H450C
		50 cms	F2984562H500C
		55 cms	F2984562H550C
		60 cms (50 Kgs)	F2984566H600C

GUIA OCULTA CON FRENO PROGRESIVO

HIFELE

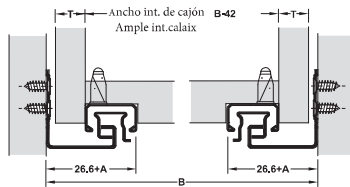

T = 16 mm  
Mida de trepant  
Medidas de taladro

Excelentes propiedades de deslizamiento, aplicable de forma universal, amortiguación con pistón de aceite, ajustable en altura hasta + 3mm, capacidad de carga de 30 Kgs, 50000 ciclos de apertura y cierre.

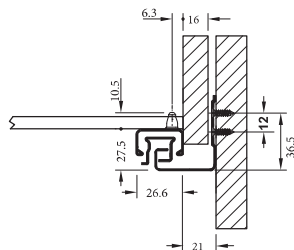
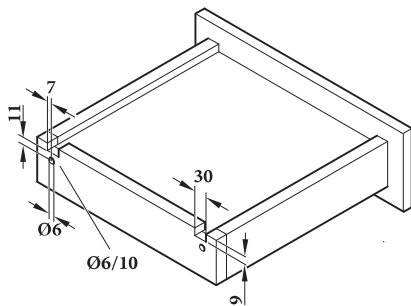

Zincado

GUIA OCULTA FRENO PROGRESIVO  
30 Kgs.

Medida	Profundidad mínima	Código
30 cms	318 mm	F309243303182
35 cms	368 mm	F309243303183
40 cms	418 mm	F309243303184
45 cms	468 mm	F309243303185
50 cms	518 mm	F309243303186

GUIA OCULTA CON FRENO PROGRESIVO



Extraccion total con freno, 50 kgs de carga, valido para costado de 16 i 19 mm. Altura regulable 0-4 mm.

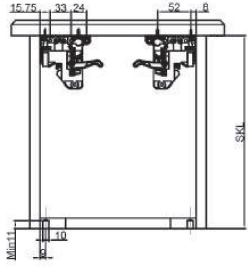
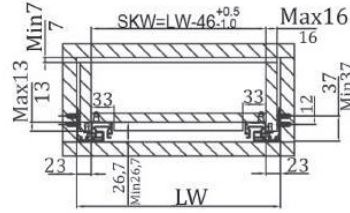

Ø6 Profundidad de perforación min 11

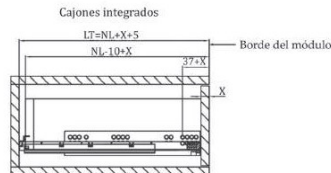
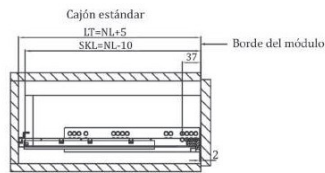
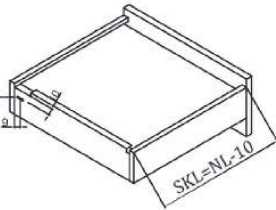

Zincado

GUIA OCULTA FRENO PROGRESIVO  
50 Kgs.

30 cms	
35 cms	F30530128350
40 cms	F30530128400
45 cms	
50 cms	F30530128500
55 cms	F30530128550

GUIA OCULTA CON FRENO PROGRESIVO



Extraccion total con freno, 50 kgs de carga, valido para costado de 16 i 19 mm. Altura regulable 0-4 mm.



Dimensiones del cajón  
SKL= Longitud del cajón  
LT= Longitud del interior del módulo (min)

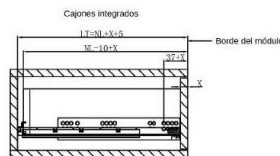
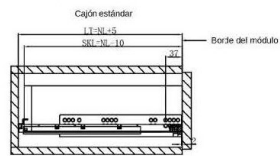

NL = Longitud nominal de la guía LT = Profundidad del interior del módulo SKL = Longitud del cajón X = Grosor del frontal del cajón

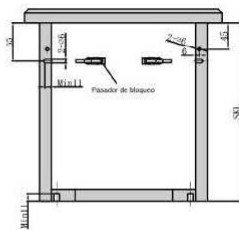
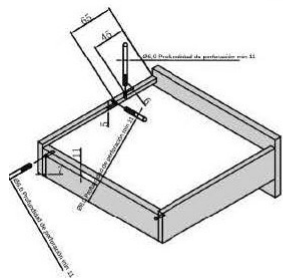

Dimensiones de montaje

Instalación para cajones con lateral de 15mm de grosor máximo.

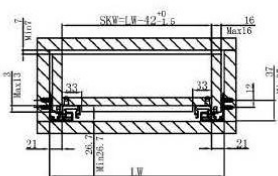

Instalación para cajones con lateral de 19mm de grosor máximo.

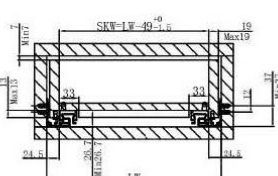

Zincado

GUIA OCULTA FRENO PROGRESIVO  
50 Kgs.

30 cms	
35 cms	F30530127350
40 cms	
45 cms	
50 cms	
55 cms	F30530127550

GUIA OCULTA CON FRENO PROGRESIVO

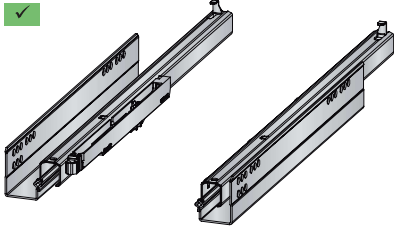

Corredera telescópica de extracción total, capaz de soportar pesos de hasta 30 kilos y que garantiza un movimiento de apertura y cierre suave y silencioso. Esta solución se monta con la última versión del amortiguador Indamatic y permite tres tipos de regulaciones: en altura, lateral y profundidad. El objetivo de esta corredera es ofrecer a los fabricantes de muebles una opción eficiente de coste para convertir muebles de extracción parcial en extracción total.

Trasera

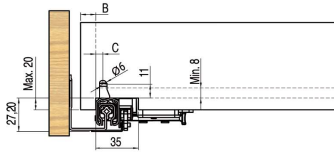

Frente

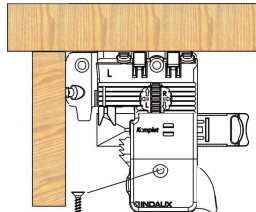
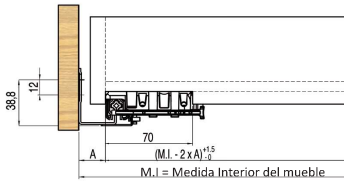

Tiraf.avellanado: Ø 3.5x20 C/plana.

En los demás agujeros se aconseja utilizar:  
Tiraf. c/cilindrica Ø 3.7x16.

A	B	C	Regulación
21	17 (max)	7	Regulación lateral limitada
19.5	14 (max)	8.5	Regulación lateral ±1.5

JGO. FIJACIONES  
REGULACIÓN

2- Alt + lat	F3064000002R
3- Alt+lat+incl	F3064000003R

Zincado ✓

GUIA OCULTA FRENO PROGRESIVO  
30 Kgs.

27 cms	
30 cms	F30640000300
35 cms	F30640000350
40 cms	F30640000400
45 cms	F30640000450
50 cms	F30640000500
55 cms	
60 cms	F30640000600

GUIA OCULTA CON FRENO

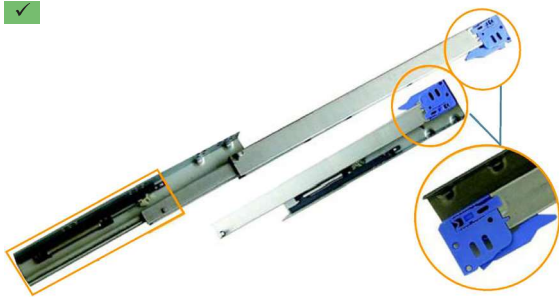

Guía cuadro de extracción total con freno y clip para carga de hasta 30 kgs.

Zincado ✓

GUIA OCULTA FRENO  
30 Kgs.

27 cms	F309910270
30 cms	F309910300
35 cms	F309910350
40 cms	F309910400
45 cms	F309910450
50 cms	F309910500
55 cms	F309910550



GUIA OCULTA PUSH



Guía cuadro de extracción total toca-toca para carga de hasta 30 kgs.

Zincado

GUIA OCULTA PUSH  
30 Kgs.

27 cms	F309900270
30 cms	F309900300
35 cms	F309900350
40 cms	F309900400
45 cms	F309900450
50 cms	F309900500
55 cms	F309900550

GUIA OCULTA CON FRENO PROGRESIVO PARA ESTANTES

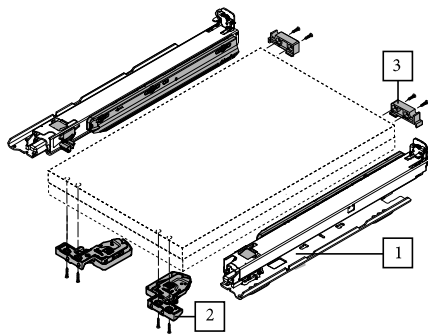
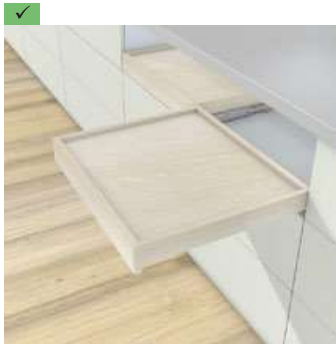

Extraccion total con freno, 50 kgs de carga, valido para costado de 16 i 19 mm. Altura regulable 0-4 mm.

Zincado

GUIA OCULTA FRENO PROGRESIVO PARA ESTANTES  
40 Kgs.

50 cms	F2984760H500BU
--------	----------------