





















































BISAGRA					
TIPO	FUNCIÓN	CLIP-TOP	BLUMOTION		TIP-ON
			CON FRENO	SIN FRENO	
TETÓN	RECTA	F358475T1580	F358471B3580	F358471T3580	F358470T5580
	RECTA 19 mm		F358473B3580	F358473T3580	
	155		F358471B7580		F358470T7550
	170	F358471T6580			
	PROLONGACIÓN		F358479B9580		
	RINCONERO PUERTA PLEGABLE	F358479T8530			
	FRIGORÍFICO PANELABLE		F358491K9580		
s/. teton	RECTA	F358475T1550	F358471B3550	F358471T3550	F358470T5550
	RECTA 19 mm		F358473B3550	F358473T3550	F358472T3550TL
	ACODADA	F358475T1650	F358471B3650	F358471T3650	
	SUPER ACODADA	F358475T1750	F358471B3750	F358471T3750	
	155 RECTA		F358471B7550		F358470T7550
	155 ACODADA		F358471B7650		
	170 RECTA	F358471T6550			
	PROLONGACIÓN	F358479T9550	F358479B9550		
	PROLONGACIÓN SOLAPADA		F358479B9980		
	45° I		F358479B9658		
	45° II		F358479B3458		
	45° III		F358479B9458		
	30° II		F358479B9556		
	30° III		F358479B9456		
	20° II		F358479B9555		
	15° III		F358479B9454		
	-15° III		F358479B3453		
	-30° III		F358479B3451		
	-45° III		F358479B3450		
	RECTA PUERTA PERFILADA 32 mm		F358471B9550	F358471T9550	
	ACODADA PUERTA PERFIL 32 mm		F358471B9650		
	SUPER ACODADA PUERTA PERFIL 32 mm		F358471B9750		
	ONIX TETON	RECTA		F3584071B3580	
155°			F3584071B7580		
HPL	RECTA		F358471B453T		
Cristallo	RECTA		F358471B4500C	+ placa	F358470T4568C

Bases				
TIPO		SIN TETON	CON TETON	EXPANDO
ECO SIN EXCENTRICA	3 mm	F3584173L6130		
NORMAL	0 mm	F3584173H7100	F3584174H7100	F3584174H710E
	3 mm	F3584173H7130		
	6 mm	F3584175H9160		
	9 mm	F3584175H7190		
	18 mm	F3584175H7192		
FRIGORIFICO PANELABLE	0 mm			F3584194K6100E
ONIX	0 mm	F35840175H3100		
CUÑAS	+5° 0.8 mm	F3584171A5010		
	+5° 3 mm	F3584171A5040		
	+5° 6 mm	F3584171A5070		
	-5° 6 mm	F3584171A5500		

BISAGRAS BLUM. GRADOS POSITIVOS.

	<p>Nº 16</p>  <p>A 71 B97 x0 B 7019750.TL C 173 H700 D 171A5010</p>	<p>Nº 46</p>  <p>A 71 B96 x0 B 7019650.TL C 173 H700 D 171A5070</p>	<p>Nº 1</p>  <p>A 71 B95 x0 B 7019550.TL C 173 H700 D 171A5010</p>	<p>Nº 36</p>  <p>A 71 B95 x0 B 7019550.TL C 173H7100 D 171A5010</p>	+5°
	<p>Nº 17</p>  <p>A 79 B94 x4 B 78 A9454 C 175H7190.22 D 171A5500</p>	<p>Nº 47</p>  <p>A 79 B94 x4 B 78 A9454 C 175H7190.22 D 171 A5500</p>	<p>Nº 2</p>  <p>A 79 B94 x4 B 78 A9454 C 173 H700 D 171 A5500</p>	<p>Nº 37</p>  <p>A 79B94 x4 B 78A9454 C 173H7100 D 171A5500</p>	+10°
<p>Nº 55</p>  <p>A 79 B95 x5 B 78 A9555 C 173 H700 D 171A5500</p>	<p>Nº 18</p>  <p>A 79 B95 x5 B 78 A9555 C 175 H790 D 171A5500</p>	<p>Nº 48</p>  <p>A 79 B95 x5 B 78 A9555 C 173 H730 D 171A5500</p>	<p>Nº 3</p>  <p>A 79 B94 x4 B 78 A9454 C 175 H790</p>	<p>Nº 38</p>  <p>A 79B94 x4 B 78A9454 C 175H9160</p>	+15°
<p>Nº 56</p>  <p>A 79 B95 x5 B 78 A9555 C 175 H9160</p>	<p>Nº 19</p>  <p>A 79 B95 x5 B 78 A9555 C 175H7190.22</p>	<p>Nº 49</p>  <p>A 79 B95 x5 B 78 A9555 C 175 H790</p>	<p>Nº 4</p>  <p>A 79 B95 x5 B 78 A9555 C 173 H700</p>	<p>Nº 39</p>  <p>A 79B94 x4 B 78A9454 C 173H7100 D 171A5070</p>	+20°
<p>Nº 57</p>  <p>A 79 B95 x6 B 78 A9556 C 173 H700 D 171A5500</p>	<p>Nº 20</p>  <p>A 79 B95 x6 B 78 A9556 C 175 H790 D 171A5500</p>	<p>Nº 50</p>  <p>A 79 B95 x6 B 78 A9556 C 173 H700 D 171A5500</p>	<p>Nº 5</p>  <p>A 79 B95 x5 B 78 A9555 C 173 H700 D 171A5010</p>	<p>Nº 40</p>  <p>A 79B94 x6 B 78A9456 C 173H7100 D 171A5500</p>	+25°
<p>Nº 58</p>  <p>A 79 B95 x6 B 78 A9556 C 173 H730</p>	<p>Nº 21</p>  <p>A 79 B95 x6 B 78 A9556 C 175H7190.22</p>	<p>Nº 51</p>  <p>A 79 B95 x6 B 78 A9556 C 175 H790</p>	<p>Nº 6</p>  <p>A 79 B95 x6 B 78 A9556 C 173 H700</p>	<p>Nº 41</p>  <p>A 79B94 x6 B 78A9456 C 175H9160</p>	+30°
<p>Nº 59</p>  <p>A 79 B95 x6 B 78 A9556 C 173 H700 D 171A5040</p>	<p>Nº 22</p>  <p>A 79 B95 x6 B 78 A9556 C 175H7190.22 D 171A5010</p>	<p>Nº 52</p>  <p>A 79 B95 x6 B 78 A9556 C 173 H700 D 171 A5070</p>	<p>Nº 7</p>  <p>A 79 B95 x6 B 78 A9556 C 173 H700 D 171 A5010</p>	<p>Nº 42</p>  <p>A 79B94 x6 B 78A9456 C 173H7100 D 171A5070</p>	+35°
<p>Nº 109</p>  <p>A 79 B94 x8 B 78A9458 C 175 H7190 D 171A5010</p>	<p>Nº 23</p>  <p>A 79 B96 x8 B 78 A9658 C 175H7190 D 171A5500</p>	<p>Nº 108</p>  <p>A 79 B94 x8 B 78 A9458 C 175 H790 D 171A5040</p>	<p>Nº 8</p>  <p>A 79 B94 x8 B 78 A9458 C 175 H9160 D 171A5500</p>	<p>Nº 43</p>  <p>A 79B94 x8 B 78A9458 C 173H7100 D 171A5500</p>	+40°
<p>Nº 60</p>  <p>A 79 B96 x8 B 78 A9658 C 173 H700</p>	<p>Nº 24</p>  <p>A 79 B35 x8 B 78 T5550 C 175H7190.22</p>	<p>Nº 53</p>  <p>A 79 B96 x8 B 78 A9658 C 173 H700</p>	<p>Nº 9</p>  <p>A 79 B35 x8 B 78 T5550 C 173 H700</p>	<p>Nº 44</p>  <p>A 79B94 x8 B 78A9458 C 175H9160</p>	+45°
<p>Nº 61</p>  <p>A 79 B96 x8 B 78 A9658 C 173 H700 D 171A5010</p>	<p>Nº 25</p>  <p>A 79 B96 x8 B 78 A9658 C 175 H790 D 171A5070</p>	<p>Nº 54</p>  <p>A 79 B96 x8 B 78 A9658 C 173 H700 D 171A5010</p>	<p>Nº 10</p>  <p>A 79 B35 x8 B 78 T5550 C 173 H700 D 171A5010</p>	<p>Nº 45</p>  <p>A 79B94 x8 B 78A9458 C 173H7100 D 171A5070</p>	+50°
					

BISAGRAS BLUM. GRADOS NEGATIVOS.

	A CLIP top BLUMOTION BCLIP top sense molla / sin muelle x INSERTA = 9 x Per cargolar / por atornillado					Nº 26	
-50°						A 79B34 x0 B 78A5450 C 173H7100 D 171A5500	
						Nº 27	
-45°						A 79B34 x0 B 78A5450 C 173H7130	
						Nº 28	
-40°						A 79B34 x0 B 78A5450 C 173H7100 D 171A5040	
						Nº 29	
-35°						A 79B34 x1 B 78A5451 C 173H7100 D 171A5500	
						Nº 30	
-30°						A 79B34 x1 B 78A5451 C 173H7130	
						Nº 31	
-25°						A 79B34 x1 B 78A5451 C 173H7100 D 171A5070	
						Nº 32	
-20°						A 79B34 x3 B 78A5453 C 175H9160 D 171A5500	
						Nº 33	
-15°						A 79B34 x3 B 78A5453 C 175H7190.22	
						Nº 34	
-10°						A 79B34 x3 B 78A5453 C 173H7100 D 171A5070	
						Nº 35	
-5°						A 71B96 x0 B 70T9650.TL C 173H7100 D 171A5500	

RECTA 107°

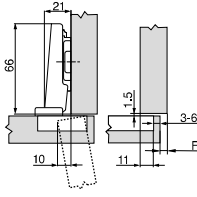
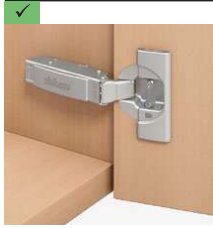

Distancia de cazoleta TB. Distància cassoleta TB.

MD	Recubrimiento del frente FA (mm). Recobrimet del front FA(mm).																
	5	6	7	8	9	10	11	12	13	14	15	16	17				
0										3	4	5	6				
3							3	4	5	6							
6				3	4	5	6										
9	3	4	5	6													
MD	Distancia de base (mm). Distància de base (mm).																

Níquel

ACODADA 107°

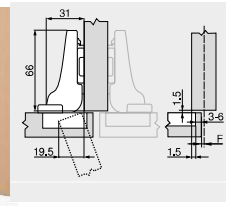
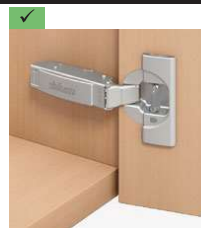

Distancia de cazoleta TB. Distància de cassoleta TB.

MD	Recubrimiento del frente FA (mm). Recobrimet del front (mm).														
	-4.5	-3.5	-2.5	-1.5	-0.5	0.5	1.5	2.5	3.5	4.5	5.5	6.5	7.5		
0										3	4	5	6		
3							3	4	5	6					
6				3	4	5	6								
9	3	4	5	6											
MD	Distancia de base (mm). Distància de base (mm).														

Níquel

RECTA 107°

	Con tetón	Sin tetón
Recta 107°	F358475T1580	F358475T1550

ACODADA 107°

	Sin tetón
Acodada 107°	F358475T1650

S/.ACODADA 107°

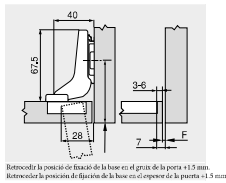
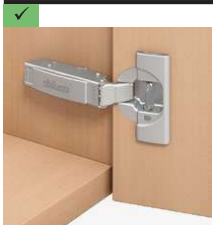

Distancia de cazoleta TB. Distància de cassoleta TB.

MD	Recubrimiento del frente FA (mm)							
	-7	-6	-5	-4	-3	-2	-1	
0					3	4	5	6
3			3	4	5	6	7	
6								
9								
MD	Distancia de base (mm)							

Níquel

S/.ACODADA 107°

	Sin tetón
Acodada 107°	F358475T1750

S/.ACODADA 107°

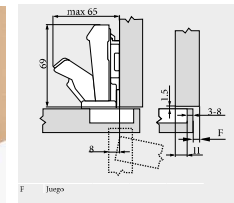

Distància de cassoleta TB. Distancia de cazoleta TB.

MD	Recubrimiento del frente FA (mm)															
	5	6	7	8	9	10	11	12	13	14	15	16	17	18	19	
0											3	4	5	6	7	8
3							3	4	5	6	7	8				
6				3	4	5	6	7	8							
9	3	4	5	6	7	8										
MD	Distància de base (mm). Distancia de base (mm).															

Níquel

RECTA 170°

	Sin tetón	Con tetón
Recta 170°	F358471T6550	F358471T6580

RECTA 110° 19 MM

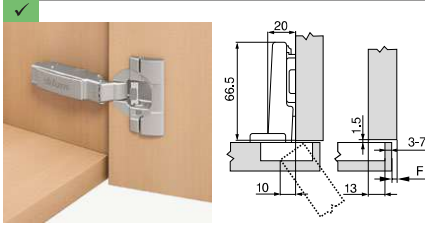

Joc mínim de joc F per a front amb radi de front (R=1mm) amb ajustament de fàbrica.
 Juego mínimo del juego F para frentes con radio del frente (R = 1 mm) con ajuste en fábrica.

Distància cassoleta. Distancia de cazoleta. TB (mm)	Espesor del front (mm). Espesor del frente FD (mm).											
	16	18	19	20	21	22	23	24	25	26	28	30
3	0.5	0.8	1.0	1.2	1.5	1.8	2.2	2.7	3.5	4.3		
4	0.5	0.8	1.0	1.2	1.4	1.7	2.0	2.5	3.1	3.8		
5	0.5	0.8	0.9	1.2	1.4	1.7	2.0	2.4	2.9	3.4		
6	0.5	0.8	0.9	1.2	1.3	1.6	1.9	2.3	2.7	3.2		
7	0.5	0.8	0.9	1.1	1.3	1.6	1.9	2.2	2.6	3.0		

Adicional per a un ajustament lat. de +2mm. Adicional para un ajuste lateral de +2 mm.
 +0.2 +0.4 +0.4 +0.5 +0.5 +0.5 +0.5 +0.5 +0.5 +0.5 +0.5

Recomanem un assaig de muntatge. Recomendamos un ensayo de montaje.

Níquel ✓

RECTA 110°
19 mm

	Sin tetón	Con tetón
Tip-on	F358472T3550TL	
Blumotion	F358473B3550	F358473B3580
S/. Blumotion	F358473T3550	F358473T3580

Níquel ✓

ACODADA 110°

ACODADA 110°

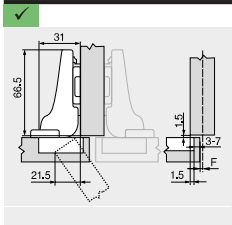

Distància de cassoleta TB. Distancia de cazoleta TB.

MD	Recobrimiento del frontal FA (mm). Recubrimiento del frente FA (mm).														
	-45	-35	-25	-15	-05	0.5	1.5	2.5	3.5	4.5	5.5	6.5	7.5	8.5	
0									3	4	5	6	7		
3							3	4	5	6	7				
6				3	4	5	6	7							
9	3	4	5	6	7										

Níquel ✓

Blumotion
S/. Blumotion

Sin tetón
F358471B3650
F358471T3650

RECTA 110°

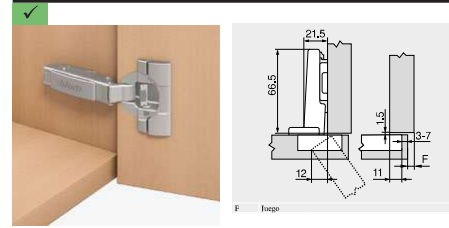

Distància de cassoleta TB. Distancia de cazoleta TB.

MD	Recubrimiento del frente FA (mm). Recobrimiento del front FA (mm).																		
	5	6	7	8	9	10	11	12	13	14	15	16	17	18					
0															3	4	5	6	7
3								3	4	5	6	7							
6					3	4	5	6	7										
9	3	4	5	6	7														

Níquel ✓
Negro ✓

RECTA 110°

	Sin tetón	Con tetón
Blumotion	F358471B3550	F358471B3580
S/. Blumotion	F358471T3550	F358471T3580
Onix Blumotion		F3584071B3580

S/. ACODADA 110°

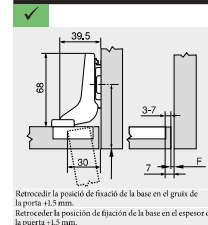

Retrocèdre la posició de fixació de la base en el gruix de la porta +1.5 mm.
 Retroceder la posición de fijación de la base en el espesor de la puerta +1.5 mm.

Distància de cassoleta TB. Distancia de cazoleta TB.

MD	Recubrimiento del frente FA (mm). Recobrimiento del front FA (mm).										
0											
3											
6											
9											

√D Distància de base (mm). Distancia de base (mm).

Níquel ✓

S/. ACODADA
110°

Sin tetón
F358471B3750
F358471T3750

ACODADA 155°

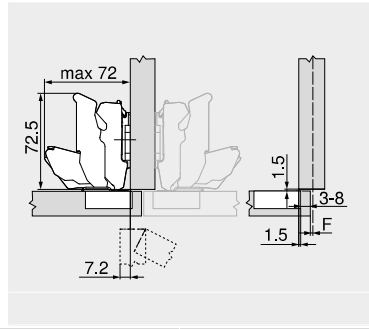

		Recobriments del frontal FA (mm). Recubrimiento del frente FA (mm)													
MD															
	-4.5	-3.5	-2.5	-1.5	-0.5	0.5	1.5	2.5	3.5	4.5	5.5	6.5	7.5	8.5	9.5
0										3	4	5	6	7	8
3							3	4	5	6	7	8			
6				3	4	5	6	7	8						
9	3	4	5	6	7	8									

MD Distància de base (mm). Distancia de base (mm)

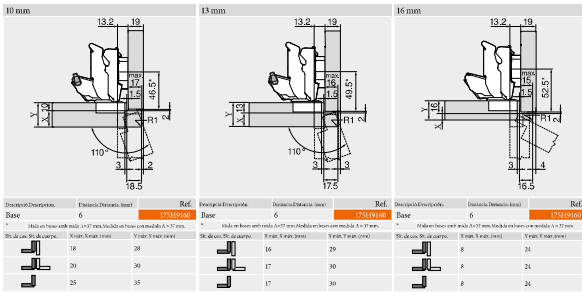
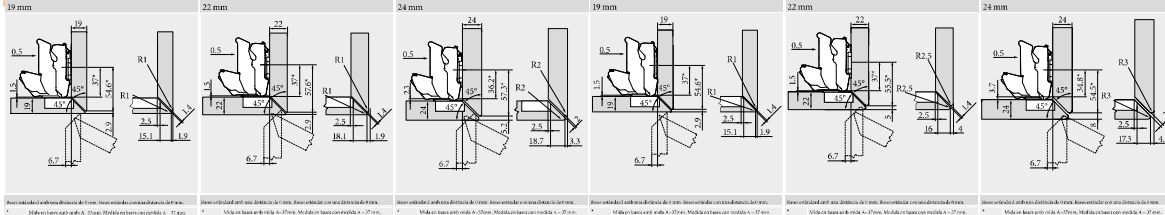

Níquel

ACODADA 155°

Blumotion	Sin tetón
	F358471B7650

RECTA PUERTA PERFILADA 32 MM

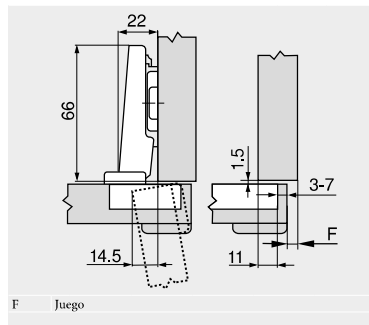

Distància cassoleta TB. Distancia de cazoleta TB

		Recobriments del frontal FA (mm). Recubrimiento del frente FA (mm).													
MD															
	5	6	7	8	9	10	11	12	13	14	15	16	17	18	
0											3	4	5	6	7
3							3	4	5	6	7				
6				3	4	5	6	7							
9	3	4	5	6	7										

MD Distància de base (mm). Distancia de base (mm).

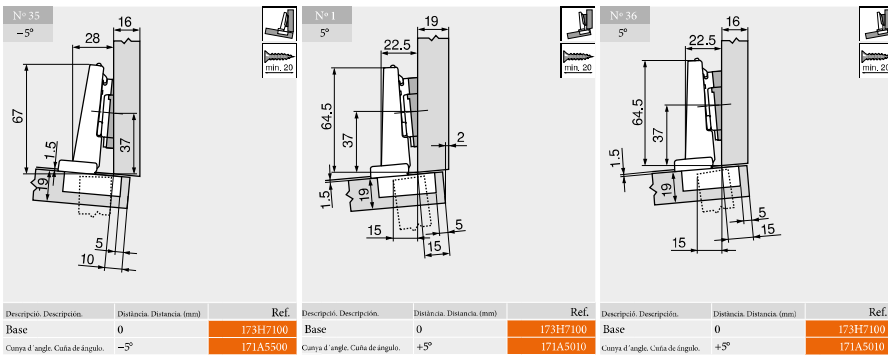

Níquel

RECTA PERFILADA 32 MM

Blumotion	Sin tetón
S/. Blumotion	F358471B9550
	F358471T9550

ACOD. PERFILADA 32 MM

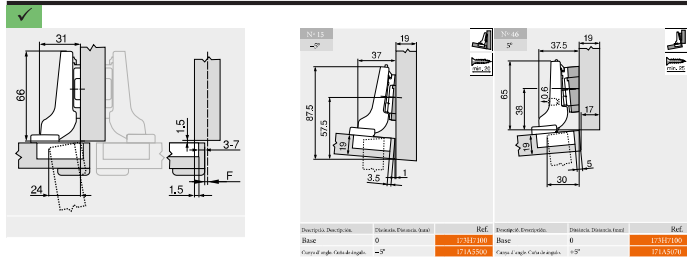

Distància cassoleta TB. Distancia de cazoleta TB

Recubrimient del frontal FA (mm).Recubrimiento del frente FA (mm).	
MD	-4.5 -3.5 -2.5 -1.5 -0.5 0.5 1.5 2.5 3.5 4.5 5.5 6.5 7.5 8.5
0	3 4 5 6 7
3	3 4 5 6 7
6	3 4 5 6 7
9	3 4 5 6 7
MD	Distància de base (mm). Distancia de base (mm).

Níquel ✓

ACODADA PERFILADA 32 MM

Sin tetón

Blumotion

F358471B9650

S/ACOD. PERFILADA 32 MM



Distància cassoleta TB. Distancia de cazoleta TB

Recubrimient del frontal FA (mm).Recubrimiento del frente FA (mm).	
MD	-7 -6 -5 -4 -3 -2 -1 0
0	3 4 5 6 7
3	3 4 5 6 7
6	
9	
MD	Distància de base (mm). Distancia de base (mm).

Níquel ✓

S/. ACOD. PERFILADA 32 MM

Sin tetón

Blumotion

F358471B9750

FRIGORÍFICO INTEGRADO

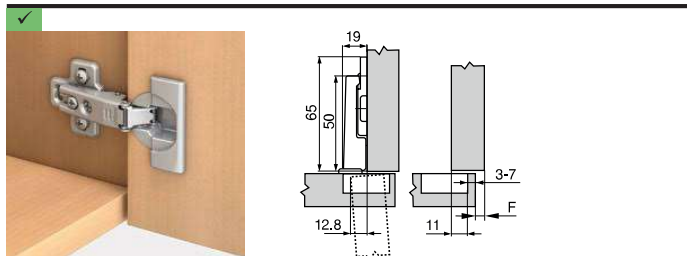

Juego mínimo del juego F para frentes con radio del frente (R = 1 mm) con ajuste en fábrica

Distancia de cazoleta TB (mm)	Espesor del frente FD (mm)											
	16	18	19	20	22	24	26	28	29	30	31	32
3	0.2	0.2	0.3	0.4	0.5	0.8	1.3	2.5	3.5	4.4	5.3	6.1
4	0.2	0.2	0.3	0.4	0.5	0.8	1.3	1.9	2.9	3.8	4.7	5.5
5	0.2	0.2	0.3	0.4	0.5	0.8	1.2	1.7	2.4	3.2	4.0	4.9
6	0.2	0.2	0.3	0.4	0.5	0.8	1.2	1.7	2.2	2.8	3.5	4.3
7	0.2	0.2	0.3	0.4	0.5	0.8	1.2	1.6	2.0	2.4	3.0	3.8
Adicional para un ajuste lateral de +2 mm												
	+0.0	+0.1	+0.1	+0.1	+0.3	+0.5	+0.4	+0.4	+0.4	+0.4	+0.3	+0.2

Níquel ✓

ACODADA FRIG. INTEGRADO 95°

Con tetón

Blumotion

F358491K9580

Base

F3584194K6100E

RINCONERO PTA. PLEGAB.

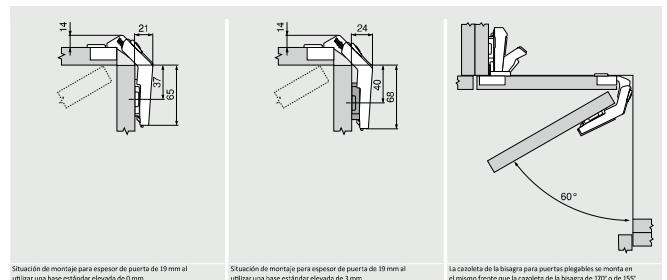
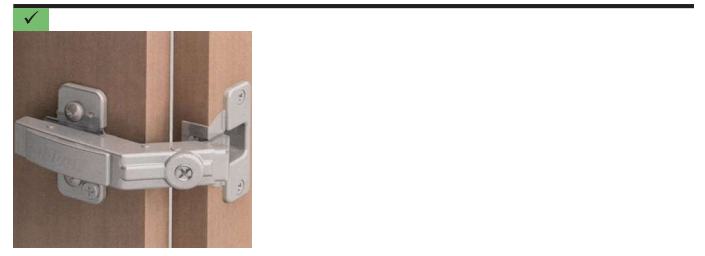

Níquel ✓

RINCONERO PTA. PLEGABLE 60°

Con tetón

Clip-Top

F358479T8530

45° I

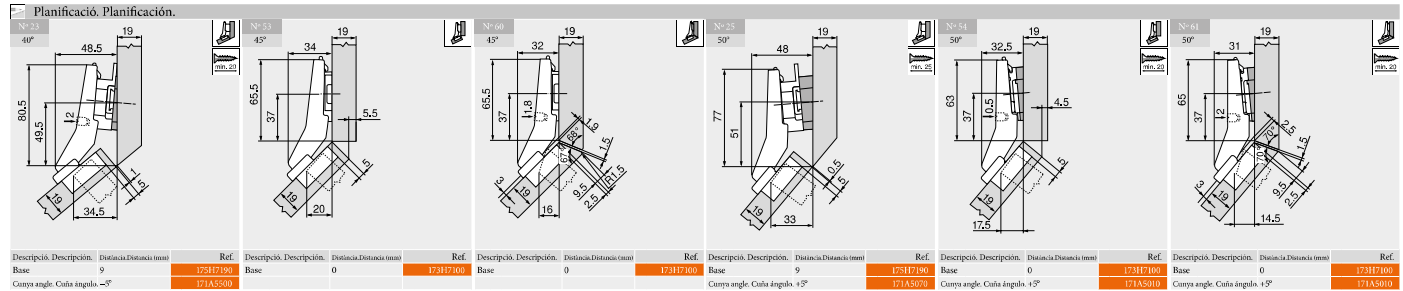

Níquel

45° I

Blumotion	Sin tetón
	F358479B9658

45° II

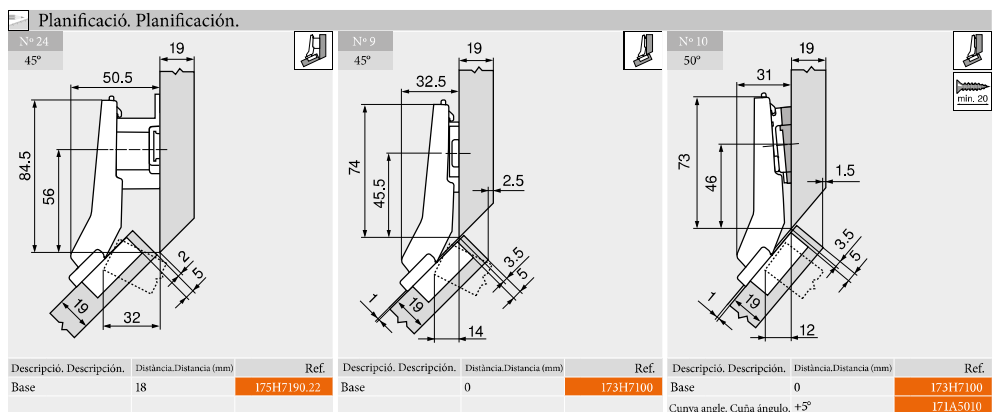

Níquel

45° II

Blumotion	Sin tetón
	F358479B3458

45° III



Planificació. Planificación.

Nº 102	Nº 42	Nº 109	Nº 44	Nº 45
Descripció. Descripción. Distancia.Distancia (mm) Ref.	Descripció. Descripción. Distancia.Distancia (mm) Ref.	Descripció. Descripción. Distancia.Distancia (mm) Ref.	Descripció. Descripción. Distancia.Distancia (mm) Ref.	Descripció. Descripción. Distancia.Distancia (mm) Ref.
Base 9 173H7193 Curva angle. Curva ángulo. +5° 171A5046	Base 6 175H9160 Curva angle. Curva ángulo. -5° 171A5500	Base 9 173H7100 Curva angle. Curva ángulo. -5° 171A5500	Base 6 175H7192 Curva angle. Curva ángulo. +5° 171A5016	Base 0 173H7100 Curva angle. Curva ángulo. +5° 171A5500

Níquel

45° III

Sin tetón

Blumotion

F358479B9458

30° II



Planificació. Planificación.

Nº 50	Nº 57	Nº 21	Nº 51	Nº 6
Descripció. Descripción. Distancia.Distancia (mm) Ref.	Descripció. Descripción. Distancia.Distancia (mm) Ref.	Descripció. Descripción. Distancia.Distancia (mm) Ref.	Descripció. Descripción. Distancia.Distancia (mm) Ref.	Descripció. Descripción. Distancia.Distancia (mm) Ref.
Base 0 173H7100 Curva angle. Curva ángulo. -5° 171A5500	Base 0 173H7100 Curva angle. Curva ángulo. -5° 171A5500	Base 18 175H7190.22	Base 9 175H7190	Base 0 173H7100
Nº 20	Nº 58	Nº 22	Nº 7	Nº 59
Descripció. Descripción. Distancia.Distancia (mm) Ref.	Descripció. Descripción. Distancia.Distancia (mm) Ref.	Descripció. Descripción. Distancia.Distancia (mm) Ref.	Descripció. Descripción. Distancia.Distancia (mm) Ref.	Descripció. Descripción. Distancia.Distancia (mm) Ref.
Base 9 173H7190 Curva angle. Curva ángulo. -5° 171A5500	Base 3 173H7190	Base 18 173H7400.22 Curva angle. Curva ángulo. -5° 171A5500	Base 0 173H7100 Curva angle. Curva ángulo. +5° 171A5070	Base 0 173H7100 Curva angle. Curva ángulo. +5° 171A5046

Níquel

30° II

Sin tetón

Blumotion

F358479B9556

30° III

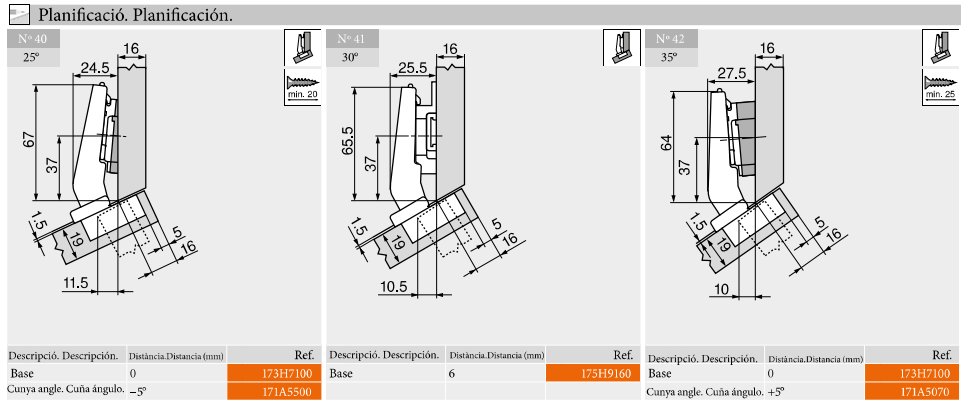
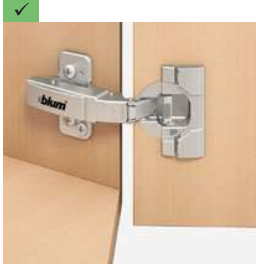

Níquel

30° III

Blumotion	Sin tetón
	F358479B9456

20° II



Níquel

20° II

Blumotion	Sin tetón
	F358479B9555

15° III

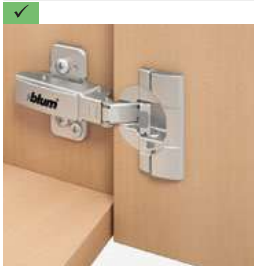

Planificació. Planificación.

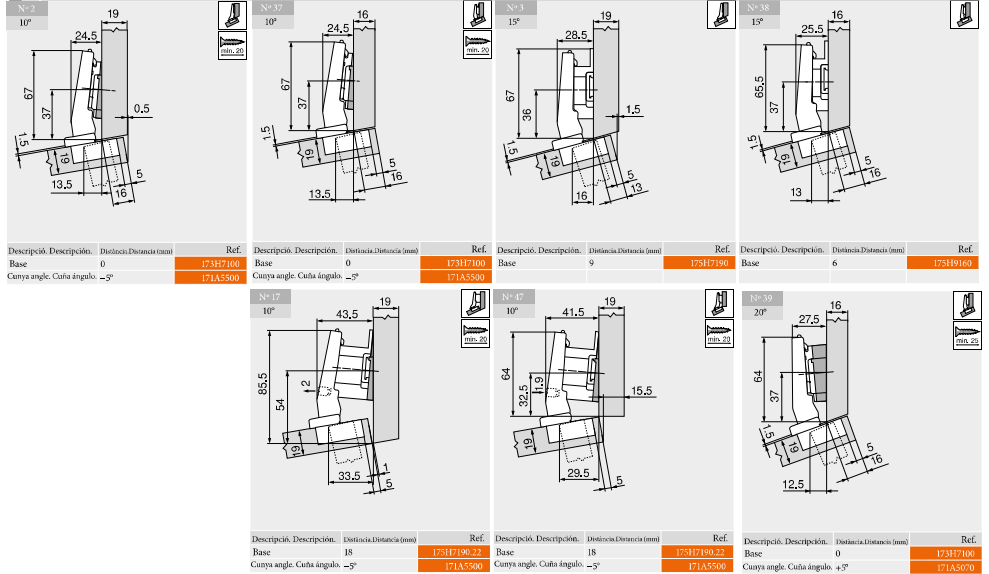

Níquel

15° III

Blumotion	Sin tetón
	F358479B9454

-15° III



Planificació. Planificación.

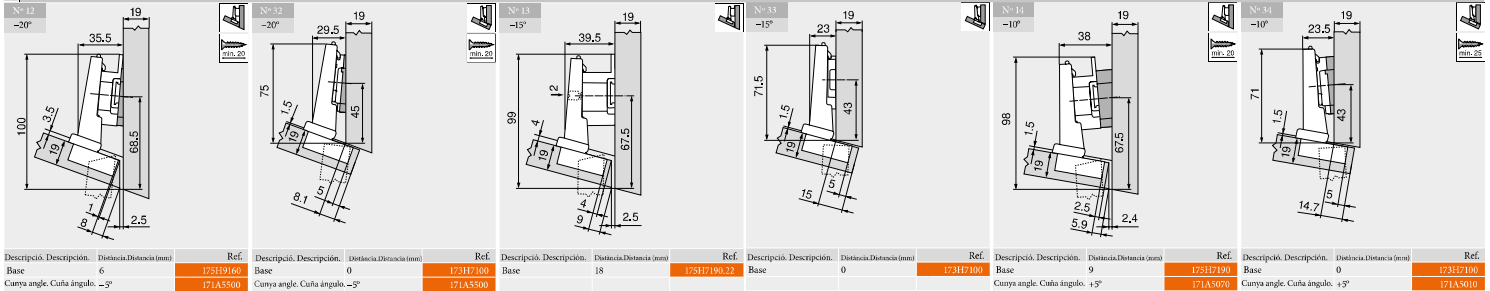

Níquel

-15° III

Blumotion	Sin tetón
	F358479B3453

-30° III

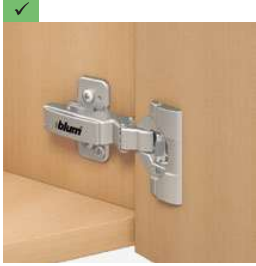

Planificació. Planificación.

Nº 29 -35°				Nº 30 -30°				Nº 11 -25°				Nº 31 -25°			
Descripció. Descripción.	Distància. Distancia (mm)	Ref.		Descripció. Descripción.	Distància. Distancia (mm)	Ref.		Descripció. Descripción.	Distància. Distancia (mm)	Ref.		Descripció. Descripción.	Distància. Distancia (mm)	Ref.	
Base	0	173H7100		Base	3	173H7130		Base	9	175H7190		Base	0	173H7100	
Cunya angle. Cuña ángulo.	-5°	171A5500						Cunya angle. Cuña ángulo.	+5°	171A5070		Cunya angle. Cuña ángulo.	+5°	171A5040	

Níquel

-30° III

Blumotion	Sin tetón
	F358479B3451

-45° III

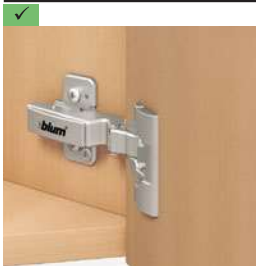

Planificació. Planificación.

Nº 26 -50°				Nº 27 -45°				Nº 28 -40°										
Descripció. Descripción.	Distància. Distancia (mm)	Ref.		Descripció. Descripción.	Distància. Distancia (mm)	Ref.		Descripció. Descripción.	Distància. Distancia (mm)	Ref.		Descripció. Descripción.	Distància. Distancia (mm)	Ref.		Descripció. Descripción.	Distància. Distancia (mm)	Ref.
Base	0	173H7100		Base	3	173H7130		Base	0	173H7100		Base	0	173H7100				
Cunya angle. Cuña ángulo.	-5°	171A5500						Cunya angle. Cuña ángulo.	+5°	171A5040								

Níquel

-45° III

Blumotion	Sin tetón
	F358479B3450

BASES

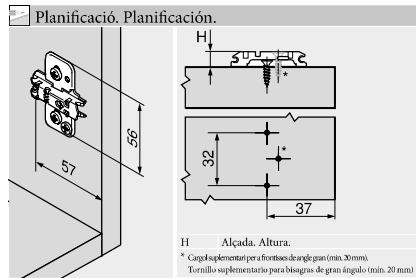
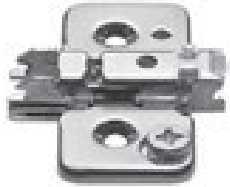

Níquel

BASE

	H=0 mm	H=3 mm
S/. Tetón	F3584173H7100	F3584173H7130
C/. Tetón	F3584174H7100	
Expando	F3584174H710E	

BASES

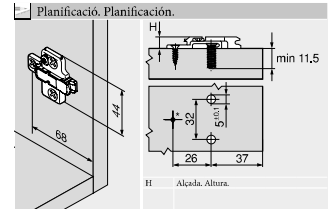

Níquel

BASE

	H=6 mm	H=9 mm	H=18 mm
S/. Tetón	F3584175H9160	F3584175H7190	F3584175H7192

BASE

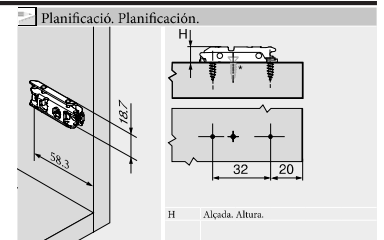

ONIX
Níquel

BASE

	H=0 mm
S/. Tetón	F2884175H3100
Onix S/. Tetón	F35840175H3100

CUÑAS

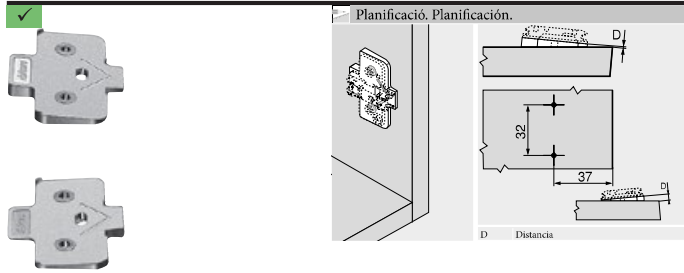

Níquel ✓

CUÑAS

Grados	D=0.8 mm	D=3 mm	D=6 mm
+5°	F3584171A5010	F3584171A5040	F3584171A5070
-5°			F3584171A5500

DISTANCIADOR CAZOLETA



Níquel ✓

DISTANCIADOR

	Código
1.5 mm	F358470T350721

LIMITADOR APERTURA

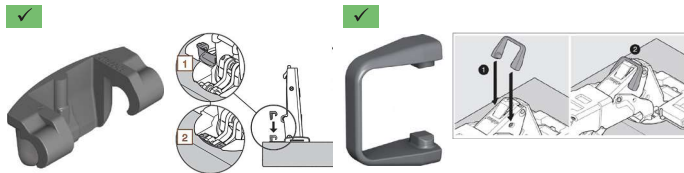

Negro ✓

TETÓN HPL



Níquel ✓

LIMITADOR

	Aplicación	Código
86°	Recta Blumotion	F358470T350721
110°	155°	F358470T7553

TETÓN HPL

	Código
Tetón	F358470T4532T
Tllo. M-4x8	F057396504008
Tllo. M-4x10	F057396504010

TAPA BISAGRA



Níquel ✓

TAPA BISAGRA

	Código
Tapa cazoleta 155°	F358470T7504
Tapa brazo 155° y 71B453T	F3584704503
Tapa brazo recta Onix	F35840701503
Tapa cazol. recta Onix	F3584070T3504