

SOPORTE CAMA

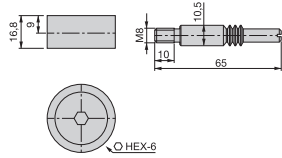

Cincado

SOPORTE CAMA

SopORTE	F38835072301
---------	--------------

UNIÓN ENCIMERAS

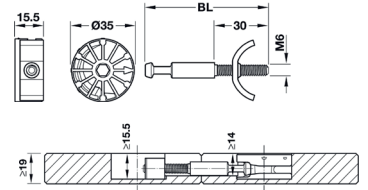

Plata

UNIÓN ENCIMERAS

Herraje	F389226287041
---------	---------------

EXCÉNTRICA

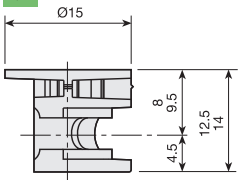

Aluminio

EXCÉNTRICA
Ø 15 mm

Excéntrica	9051100
------------	---------

PERNO SIMPLE

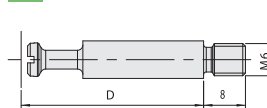
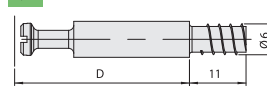

Cincado

PERNO SIMPLE

Rosca madera	9051200
M-6	9051201

PERNO AUTOEXPANSIBLE

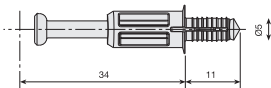

Cincado

PERNO AUTOEXPANSIBLE

Perno	9051200
-------	---------

TAPA EXCÉNTRICA

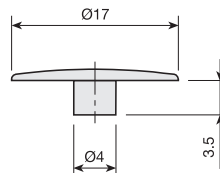

Cincado

PERNO AUTOEXPANSIBLE

Marrón	9051300
Níquel	9051301

SISTEMA RAFIX

HÄFELE

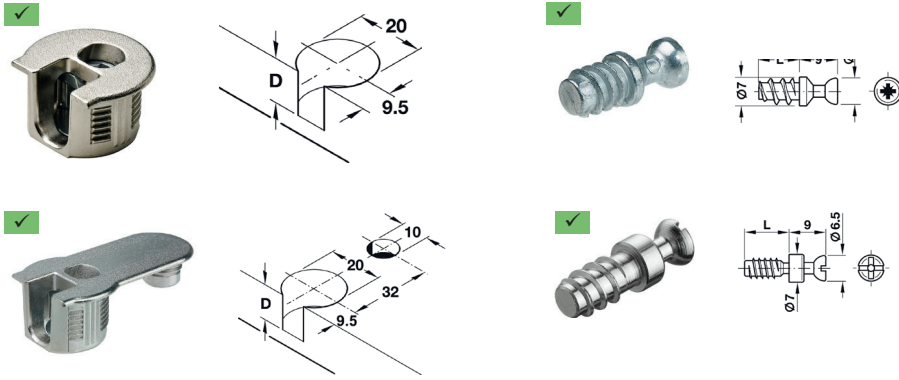

Níquel ✓

SISTEMA RAFIX

16 mm	F389226311703
19 mm	F389226311705
16 mm tetón	F389226313703
19 mm tetón	F389226313705
Perno 7.4 mm	F389226320131
Perno 11 mm	F389226320141

SISTEMA MINIFIX

HÄFELE

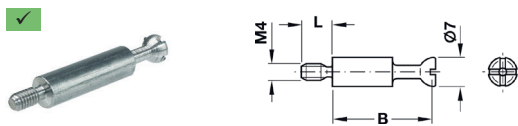

Cincado ✓

PERNO

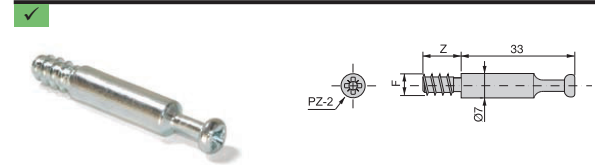

Aluminio ✓

SISTEMA MINIFIX

M-4 / 34	F389226228035
----------	---------------

PERNO SIMPLE

Rosca madera	F3883051378
M-6	F3883051379

EXCÉNTRICA

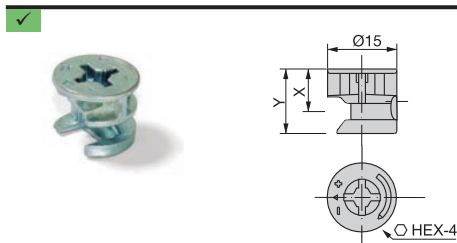

Aluminio ✓

EXCÉNTRICA
Ø 15 mm

Descripción	X x Y	Código
Para 16 mm	8 x 12.5 mm	F3883050369
Para 19 mm	9.5 x 14 mm	F3883050367

Blanco - latón ✓

TORNILLO MEDIA LUNA



TORNILLO MEDIA LUNA

35 mm	F3846A125M
-------	------------

EXCÉNTRICA

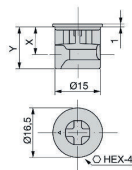

Aluminio

EXCÉNTRICA

Ø 15 mm

Descripción	X x Y	Código
Para 18 mm	9 x 14 mm	F38838007007
Para 25 mm	12.5 x 17.5 mm	F38838006707

PERNO ANILLADO

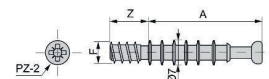

Aluminio

PERNO ANILLADO

Descripción	A x Z x F	Código
Rosca madera	23 x 8 x EU M6	F38835139805